

ISDN PBX-System

Manual

AS 281 All-In-One
AS 35
AS 35 All-In-One



AGFEO
einfach | perfekt | kommunizieren

Safety Notes

- Installation and Maintenance of the System only by trained personnel.
- Important! To prevent personal injury and damage to equipment please ensure that the system is properly earthed and that the appropriate cable is connected in the mains plug.
- The System must be installed horizontal so that the connection panel is on the right hand side.
- Do not connect or disconnect any PSTN lines during a thunderstorm.
- Install lines and extensions in such a way that no one walks or trips over them.
- Disconnect the System from the mains supply before opening the connection panel.
Before connection of lines and extensions please ensure that the system is unplugged from the mains supply. DANGER!
- Preventive measure! Before carrying out any installation work, please touch briefly the PC/Printer socket of the telephone system. This will discharge any possible electrostatic charges, thus protecting the telephone system's electrostatically sensitive components.
- Do not allow liquids to enter the system as short-circuits may occur.
- No liability will be accepted for consequential damages such as an unintentional continued connection of a line.
- The telephone system will not operate in case of power failure and you will not be able to make any type of call.

The AS 35 is indented for the connection to Basic Rate ISDN lines (DSS1, Point to Point, System Access, or Point to Multi Point, Standard Access).

The AS 281 All-In-One and AS 35 All-in-One can be connected to Basic Rate ISDN lines (DSS1, Point to Point, System Access, or Point to Multi Point, Standard Access) and may also be connected to analogue exchange lines.

Should you operate the AS 35 All-In-One on an analogue exchange line, then please ensure that your telephone service provider has meter pulse sending disabled as this may otherwise interfere with speech quality of a call.

You may connect any equipment which has been approved for the connection to the Public Switched Telephone Network (PSTN) to the extension port of the system.

Any DSS1 ISDN device which has been approved for the connection to the ISDN telephone exchange may be connected to the internal SO Bus. In addition you may connect up to two digital AGFEO System Phones to each SO Bus.

Any other use of the telephone system which is not listed or described is prohibited.

The telephone system has been issued with a universal connection licence.

The system fulfils the specified conformity and safety regulations.

About This Manual

The instruction is valid for the default setting of the system. If the system should be modified due to software made available through the manufacturer then it may be possible that sections of the instruction manual become invalid. All listed ISDN features will be supported by the system. However, some features may not be available through the Network Operator.

Introduction

Tables of Content

Introduction

Safety Notes	E - 2
About This Manual	E - 2
The AS 281 All-In-One Telephone System	E - 6
The AS 35 Telephone System	E - 7
The AS 35 All-In-One Telephone System	E - 8
Important notes on using analogue equipment	E - 9
CTI - computer telephony integration	E - 11
System telephones	E - 12
Pictograms and Buttons	E - 12

Installation

Check contents of delivery	I - 3
Wall Mounting	I - 4
Open Connection Cover	I - 4
Connect Analogue Extensions	I - 10
External S0-Connection Fixed S0	I - 10
Internal S0-Connection	I - 12
Connect the AS 281 All-in-one/	I - 13
AS 35 All-In-One to an analogue exchange line	I - 13
Door Phone	I - 14
Commissioning	I - 15
Technical Data AS 281 All-In-One	I - 17
Technical Data AS 35	I - 18
Technical Data AS 35 All-In-One	I - 19

Operation

System Phone ST 40	1 - 2
Notes on using this Manual	1 - 4
System Telephones - Settings	1 - 4
Button Assignment	1 - 7
Function Buttons - Freely programmable Function Buttons (overview)	1 - 8
External Line Access	1 - 10
Making a Call	1 - 11
External Access with specific MSN	1 - 13
Reserving an Outside Line	1 - 13
Accepting Incoming Calls	1 - 15
Call Transfer	1 - 17
Call Waiting/ Callback when free	1 - 19
Transfer an Outside Line	1 - 19
Call Waiting	1 - 21
Call Pick Up	1 - 22
Call Log	1 - 23
Do Not Disturb	1 - 25
Switching between Day and Night Service	1 - 26
Switching Call Forwarding (Extension Call Forwarding) on/off	1 - 28
Call Deflection - Forwarding a call during the ringing phase	1 - 30
Reject a call during the ringing phase	1 - 30
Auto Dialling (Hotline)	1 - 31

Introduction

Tables of Content

Busy on Busy	1 - 33
Voice Message	1 - 34
Announcement	1 - 34
To place a Call on Hold	1 - 36
Remote Dial Functions	1 - 37
Malicious Call Identification (MCID)	1 - 38
Conference	1 - 40
Least Cost Routing (LCR)	1 - 42
Carrier Access Code – on a Call by Call basis	1 - 43
Call Split (Brokers Call)	1 - 44
switching between calls	1 - 44
Call Log	1 - 45
Parking a Call	1 - 46
Baby Listening / Room Monitor	1 - 48
Enquiry	1 - 50
Automatic Call Back	1 - 52
View Extension Status	1 - 53
Set Extension Names	1 - 53
Enter Names with number buttons	1 - 54
Storing Phonebook Numbers	1 - 55
(Central Dialling Memory)	1 - 55
Dialling Numbers from the Phone Book	1 - 60
Telephone Lock - Emergency/Direct Call (Baby Call)	1 - 63
Appointment Call (Non-Recurring)	1 - 66
Timer Control	1 - 67
Switching over the door call variant	1 - 68
Doorphone Diversion to External Number	1 - 69
Operating the Doorphone and Door opener	1 - 71
Communicating a caller's phone	1 - 72
number on the internal S0 bus	1 - 72
Sending CLIP or COLP	1 - 72
Diversion from - Divert other	1 - 74
Extensions	1 - 74
Diversion to -diverting calls to another phone	1 - 75
Call Forwarding	1 - 77
Display call charges	1 - 80
Print Call Charges	1 - 81
System Redial	1 - 84
Wake Up Call	1 - 85
Single Button Dialling	1 - 88
Groups	1 - 89
Account Codes	1 - 90
Call Filter	1 - 91
Call Through	1 - 92
CLIP - Display Caller Number	1 - 93
Keypad function	1 - 93
Switchbox	1 - 94

Introduction

Tables of Content

AIS-Module

Integrated AIS-Module	2 - 1
Transferring Messages and Music-on-Hold	2 - 4
Music on Hold (MoH)	2 - 4
Messages	2 - 5
Greetings	2 - 5
Wake Up Call	2 - 6
Setting the Configuration Tool TK Suite	2 - 7
Music on Hold	2 - 7
Announcement before Answer	2 - 8
Announcement before Answer with DDI (Auto Attendant)	2 - 9
Welcome Message (Mode "Transfer")	2 - 10
Time at which an Extension should ring	2 - 10
Announcement during Ringing Phase	2 - 10
Allocation of Welcom Message	2 - 10
Allocation of On Hold Message	2 - 11
Allocation of Door Phone Announcements	2 - 11
Allocation of Sensor Announcements	2 - 11
Recording of Announcements from Sytem Phones	2 - 11
Standard Music	2 - 12

Programming

Programming via PC	3 - 3
Programming from the system telephone or a/b telephone	3 - 4
Adjusting the flash time	3 - 6
Setting the ringer rhythm for incoming external calls	3 - 7
Variable call times of the TFE's	3 - 8
Protecting functions of the telecommunications (code numbers)	3 - 8
Maintenance/ Testing	3 - 11
System phone registration	3 - 14
System phone deregistration	3 - 14
Remote setting - Remote configuration	3 - 15
Downloading new software	3 - 17
Transfer on Hang Up	3 - 18
Advanced Users Programming	3 - 19
Programming tree	3 - 20

Communication via PC

Software Overview	PC - 3
-------------------------	--------

Appendix

Glossary	A - 2
Appendix	A - 12
Tones	A - 13

Index

Index	S - 2
Declaration of Conformity	S - 5

Introduction

The AS 281 All-In-One Telephone System

The AS281 All-In-One is so much more than “just” a telephone system for the connection to the analogue telephone exchange. With the option to select the operation of an internal or external SO Bus the system may also be operated with a mixture of lines, analogue – or ISDN lines.

The connection to Internet Telephony Providers to use services such as Voice over IP is also possible without any problems. The AS 281 All-In-One will also support Voice over IP services via an Analogue Telephone Adaptor (ATA) which allows access to the SIP Gateway of the IP Provider. The port of the analogue exchange line will be connected to the output of the ATA and therefore all extensions connected to the telephone system can make calls via the IP network of the various providers.

The connection of the telephone adaptor (ATA) to the exchange line side of the telephone system will offer the use of features like exchange line access, CTI, Call Diversion, Least Cost Routing, CLIP etc. The familiar operation for the extension user remains unchanged.

Basic configuration of the AS 35 All-In-One:

- 2 Analogue Exchange Lines
- 1 SO Bus External (ISDN Line) or internal (Digital Phones)
- 8 POT Ports for analogue equipment of which 1 can be used for a door phone
- 1 PC Connection (RS232)
- 1 USB Port for PC programming
- 1 AIS Module (Audio Information System)
- Software Package TK Suite Basic

Optional:

- AGFEO DECT SO Base via an internal SO Bus

Note

Some products may only be available in certain countries.
Please ask your dealer for further information.

Introduction

The AS 35 Telephone System

The AGFEO AS 35 is configured for up to 18 extensions and offers in addition an integrated AIS Module. The AIS (Audio Information System) offers automatic announcements of advertising, music on hold, door phones - or security messages and wake up calls.

Basic configuration of the AS 35:

- 1 SO Bus External (ISDN Line)
- 3 SO Bus External (ISDN Line) or internal (Digital Phones)
- 12 POT Ports for analogue equipment of which 1 can be used for a door phone
- 1 PC Connection (RS232)
- 1 USB Port for PC programming
- 1 AIS Module (Audio Information System)
- Software Package TK Suite Basic

Optional

- AGFEO DECT SO Base via an internal SO Bus

Note

Some products may only be available in certain countries.
Please ask your dealer for further information.

Introduction

The AS 35 All-In-One Telephone System

The AS 35 All-In-One is so much more than “just” a telephone system for the connection to the analogue telephone exchange. With the option to select the operation of an internal or external SO Bus the system may also be operated with a mixture of lines, analogue – or ISDN lines.

The connection to Internet Telephony Providers to use services such as Voice over IP is also possible without any problems. The AS 35 All-In-One will also support Voice over IP services via an Analogue Telephone Adaptor (ATA) which allows access to the SIP Gateway of the IP Provider. The port of the analogue exchange line will be connected to the output of the ATA and therefore all extensions connected to the telephone system can make calls via the IP network of the various providers.

The connection of the telephone adaptor (ATA) to the exchange line side of the telephone system will offer the use of features like exchange line access, CTI, Call Diversion, Least Cost Routing, CLIP etc. The familiar operation for the extension user remains unchanged.

Basic configuration of the AS 35 All-In-One:

- 2 Analogue Exchange Lines
- 2 SO Bus External (ISDN Line) or internal (Digital Phones)
- 12 POT Ports for analogue equipment of which 1 can be used for a door phone
- 1 PC Connection (RS232)
- 1 USB Port for PC programming
- 1 AIS Module (Audio Information System)
- Software Package TK Suite Basic

Optional:

- AGFEO DECT SO Base via an internal SO Bus

Note

Some products may only be available in certain countries.
Please ask your dealer for further information.

Introduction

Important notes on using analogue equipment

Only analogue Apparatus which are approved to be connected to the Public Switched Telephone Network (PSTN) may be connected to the analogue side of the system. This includes all 2 wire telephones, answering -, fax machines, and modems.

The system supports both dialling method Loop Disconnect (LD) or Dual Tone Multi Frequency (DTMF). DTMF is a faster dialling method. The system will dedect the dialling method automatically.

From an analogue phone, you can call any extension free of charge by dialling the internal phone number. You can call an external number after seizing an outside line.(B channel)To do this dial **[9] ([0])** to get an outside line and then dial the telephone number required.

If you set "spontaneous exchange line seizure with internal " for your telephone extension then you must press the hash button before the internal phone number. Note in this mode you cannot call an extension if your phone is an older LD or rotary type dial phone.

To carry out system functions, your phone must have a STAR Button (**[*]**). The sequence to enter will be **[*]** followed by the function number. If your phone is an older type LD phone then you can dial **[9][9]** instead of **[*]** .

To make an enquiry call you phone must have an **[R]** Button (Recall Button). The signalling for this must be set to Timed Break Recall (TBR). On older rotary dial phones you do not need to press the **[R]** Button when making an enquiry call. System functions such as last number redial, abbreviated dialling etc, can be carried out from any LD phone. Details of such operations are given in this manual and in the short reference guide under Analogue and ISDN Terminals.

You can also use the functions of a standard analogue telephone (e.g. redial, abbreviated dialling) in conjunction with your telephone system. Please refer to the operating instructions for the telephone concerned for details of these functions.

Details of how to operate the functions of your telephone system that you are able to use from a standard analog telephone set to DTMF are given in this instruction manual and in the „short-form operating instructions for analogue and ISDN terminals“.

Each programming entry will be acknowledged by a confirmation tone. If this tone is not received or if an error tone is returned then you must repeat this entry.

The telephone system is forwarding counting pulses to analogue terminals to display connection charges (charge pulses).

For data transfer via the analogue ports, the telephone system supports the V.90 standard (up to 56600 bps, a reduction in speed is possible due to transmission path and cables used, down to 33600 bps V.34+).When operating a modem, it is imperative to configure the modem to blind dialling because most modems do not detect the dial tone of a telephone system.On modems that operate with the Hayes command set, blind dialling is set by means of the X0..X4 parameters.

Introduction

Important notes on using ISDN terminals

You may connect up to eight ISDN terminals to one S0 Bus of the telephone system.

ISDN terminals:

- AGFEO Digital System Telephones
- ISDN Telephones
- ISDN Cards
- ISDN Fax Machines

Depending on current consumption, you may connect at least four ISDN terminals that do not have a power supply of their own.

Example: 4 ISDN telephones or 2 digital system telephones plus 2 ISDN telephones.

All ISDN terminals must be approved ISDN terminals [DSS 1].

The internal S0 access is like a point-to-multipoint connection any available extension number from the system may be assigned to it. The 2 digit extension number will be treated like a multiple subscriber number (MSN). You can enter one or several of these MSN's in your ISDN terminal. If you should use this method, then please refer to the ISDN terminal's operating instruction. The multiple subscriber number is the ISDN -terminal's internal and Direct Dial Inward (DDI) number.

From an ISDN terminal, you call any internal extension free of charge by dialling the corresponding internal phone number. You can make external calls after seizure of an outside line by dialling **[9] ([0])**. If the port is set to 'spontaneous exchange line seizure with internal' then you must press the **[R]** button before dialling an internal number. If your Terminal has no **[R]** button or does not support this function then it will not be possible to make internal calls. ISDN telephones must use the same functions as analogue phones. For example you must press the star button before a function code is dialled. For ISDN phones that do not have a star button, you dial **[9][9]** instead.

To make an enquiry call you must have an R button on your ISDN telephone.

When programming the system, please ensure that the system confirmation tone is returned to you. If the confirmation tone is not returned or you receive an error tone, then you must re-enter the last entry.

The following can be displayed on your ISDN telephone:

- Caller's phone number (internal and -external)
- Connection charges
- Date and time after the first internal -connection

You can only make restricted use of the menu prompt functions.

Introduction

CTI - computer telephony integration

TK-Suite Client

With this Telephone System we included the Software Pack TK-Suite, this contains the CTI application TK-Suite Client. With this it will be possible to dial telephone numbers direct from your PC, see calls on your monitor and return calls direct from the missed call list. The capability can be looked up via the online help by pressing F1 on your PC at any time.

TAPI

Contrary to TK-Suite Client, the TAPI (Telephony Applications Programming Interface) is not an independent CTI application, but an interface between a TAPI-compatible Windows application and the telephone system. If the program or applications supports this then it will be possible to control the entire telephone system. The range of control is depending on the application you are running. However, in most cases you will be able to set up outgoing calls and display the arrival of incoming calls.

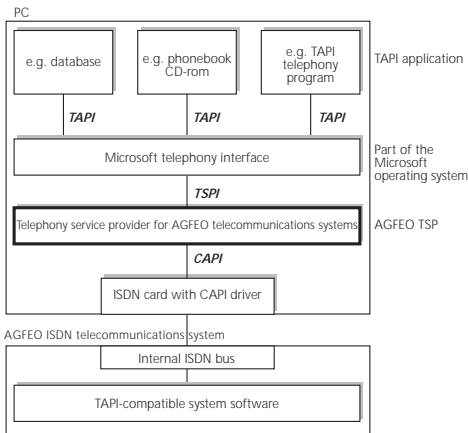

TAPI is an interface of the Microsoft operating system at the application end of Microsoft's telephone interface. A Telephony Service Provider (TSP) from the manufacturer of the ISDN hardware - in this case AGFEO - is needed to link this to the phone system. The TSP is a driver that must be installed on your PC to run the TAPI functions and to control the necessary exchange of data between the PC and telephone system.

Due to the constant increase of functions of these applications that support TAPI the TSP is always updated. To ensure that the latest version is available to you we provide this TSP totally free of charge on our Internet home page <http://www.agfeo.de>. The self-extracting file contains all the information needed for the installation of this program. Should you have no internet access, then please contact your Dealer.

Notes









CTI - computer telephony integration via TK-Suite Client or TAPI is only possible with analogue- or AGFEO System Phones.

Introduction





Pictograms and Buttons

All operations and functions of the telephone system is explained in clear and easy to follow pictograms.

Pictograms

	Ringer (tone ringing)		Conduct a call
	Pick up receiver		Replace receiver
	Dial Phone or Code Number		Conference
	Acknowledgement tone		Room monitor

Buttons

	Recall Button		Star Button for functions
	Number Button for entering digits, e.g. „9”		Hash Button to dial extension when automatic line seizure is active

System telephones

You may also use System Phones this will aid the ease of operation of your AGFEO ISDN Telephone System.

There are two different models available

-Digital ISDN System Telephone ST 21

-Digital ISDN System Telephone ST 30

-Digital ISDN System Telephone ST 40

The digital ISDN System Telephones ST 21, ST 30 and ST 40 can be connected to any internal SO bus of the AGFEO Telephone System.

Up to two ST 21, ST 30 or ST 40 can be connected to an internal SO Bus.

In the following the using of your telephone System with a ST 40 and ISDN and analogue Telephones is described.

Installation

Safety Notes

- Installation and Maintenance of the System only by trained personnel.
- Important! To prevent personal injury and damage to equipment please ensure that the system is properly earthed and that the appropriate cable is connected in the mains plug.
- The System must be installed horizontal so that the connection panel is on the right hand side.
- Do not connect or disconnect any PSTN lines during a thunderstorm.
- Install lines and extensions in such a way that no one walks or trips over them.
- Disconnect the System from the mains supply before opening the connection panel.
Before connection of lines and extensions please ensure that the system is unplugged from the mains supply. DANGER!
- Preventive measure! Before carrying out any installation work, please touch briefly the PC/Printer socket of the telephone system. This will discharge any possible electrostatic charges, thus protecting the telephone system's electrostatically sensitive components.
- Do not allow liquids to enter the system as short-circuits may occur.
- No liability will be accepted for consequential damages such as an unintentional continued connection of a line.
- The telephone system will not operate in case of power failure and you will not be able to make any type of call.

The AS 35 is indented for the connection to Basic Rate ISDN lines (DSS1, Point to Point, System Access, or Point to Multi Point, Standard Access).

The AS 35 All-in-One can be connected to Basic Rate ISDN lines (DSS1, Point to Point, System Access, or Point to Multi Point, Standard Access) and may also be connected to analogue exchange lines.

Should you operate the AS 35 All-In-One on an analogue exchange line, then please ensure that your telephone service provider has meter pulse sending disabled as this may otherwise interfere with speech quality of a call.

You may connect any equipment which has been approved for the connection to the Public Switched Telephone Network (PSTN) to the extension port of the system.

Any DSS1 ISDN device which has been approved for the connection to the ISDN telephone exchange may be connected to the internal SO Bus. In addition you may connect up to two digital AGFEO System Phones to each SO Bus.

Any other use of the telephone system which is not listed or described is prohibited.

The telephone system has been issued with a universal connection licence.

The system fulfils the specified conformity and safety regulations.

Installation

Check contents of delivery

- 1 Telephone System
- 1 Installation material (3 Wall Plugs S6,3 Wood Screws,Phillips 4x40)
- 1 Analogue connecting Cable (AS 35 All-In-One only)
- 2 ISDN connecting Cables (IAE-single wires)
- 1 RS 232 PC connection Cable
- 1 USB Connection Cable
- 1 Template
- 1 Instructions Pack
- 1 CD-ROM with TK-Suite and the AIS Konfigurator

The operating instruction in PDF format can be found on our homepage www.agfeo.de

Select Location

Install the System in a dry room free of any hazardous materials. Avoid sites near Air Conditioners, Radiators, Equipment with excessive high radiation, direct sunlight, excessive dust and the danger of liquid spillages such as Water or Chemicals.

Ambient Temperature 5C to 30 C. Max humidity 70% non condensing.

The distance of the equipment to other objects such be considered to guarantee an air circulation. The minimum clearance distance of 50 cm should be adhered to. The distance of the system to the mains socket and the telephone network socket should not be more than 1 meter. (Length of mains cable 1.20 m)

It must be made possible to place a Laptop or PC near the telephone system for programming.

Mains Socket

A separate mains socket for the telephone system should be installed. This will assist to give uninterrupted service in case that a mains fuse is tripped. The power consumption of the telephone system is approx 50 VA.

Please ensure that the system cover is replaced before connecting the equipment to the mains.

Warning! The telephone system must be electrically earthed. Please ensure that the mains socket is properly earthed before connecting the equipment to it.

Installation

Wall Mounting

The system must be mounted on the wall so that the connectors are at the bottom of it. Use the mounting 1, 2, and 3 to fix the equipment to the wall.

- Use the template to mark the screw position.
- Before drilling ensure that there is no Mains, Water or Gas supply hidden in the wall.
- Use a masonry drill bit of 6 mm and drill to a depth of 40 mm,
or
- Wood Drill 3.5 mm Drill Depth 35 mm
- Insert Wall Plug and Screw, Screwhead distance from wall approx 3 mm.--
- Place the system on top of the screws and pull downwards until in place.
- Use last screw to secure system to wall.

Open Connection Cover

- Use a Screwdriver to press into the cut out of the connection cover.
- Pull the cover from the main housing in the direction of arrow

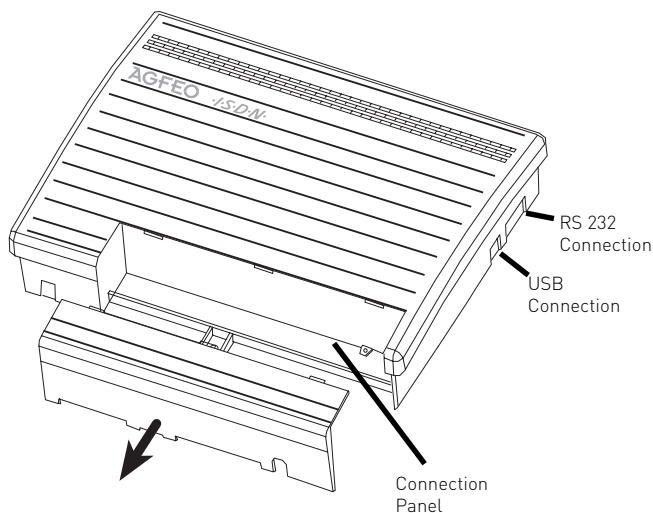

! Warning: Before opening ensure that the system is disconnected from mains supply!

Installation

Safety Notes

Please note the following:

- Before the installation or exchange of a module
- Before connection or disconnection of a line

1. Disconnect the System from the Mains Supply.
2. Disconnect all RJ Plugs of all external ISDN Lines either on the Network Termination Point or the SO Bus
3. With your finger touch the RS232 connection at the underside of the system to discharge any static electricity and to protect static sensitive components in the telephone system.

Connections of the AS 281 All-In-One

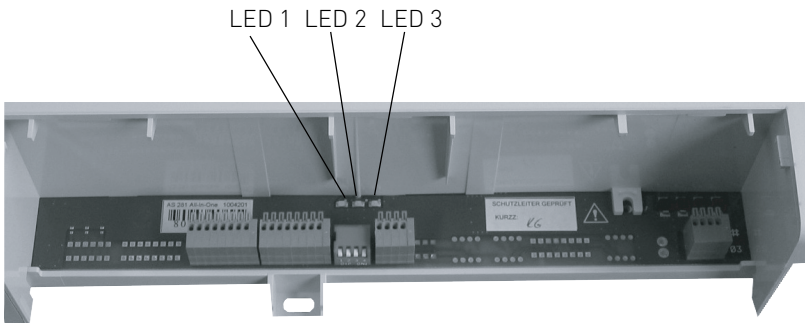

Opened Connection Panel of the AS 281 All-In-One

Installation

Connections of the AS 35

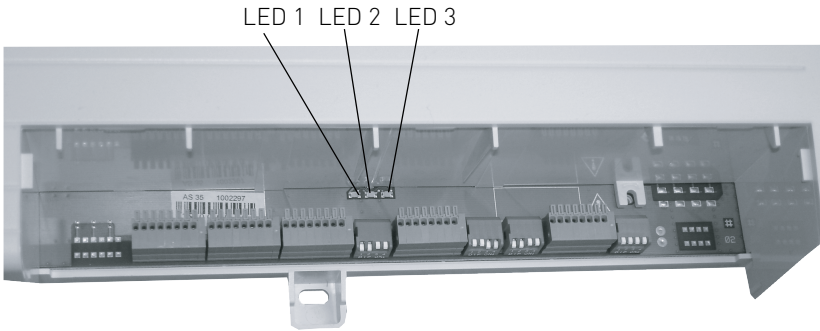

Opened Connection Panel of the AS 35

Connections of the AS 35 All-In-One

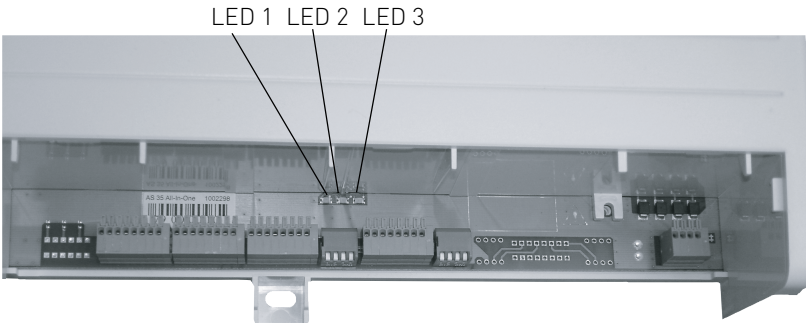

Opened Connection Panel of the AS 35 All-In-One

LEDs of the AS 281 All-In-One/ AS35 / AS 35 All-In-One

	Permanently lit	Flashes
LED 1 (green)	System is operational	System being initialised
LED 2 (red)		Data being transferred via RS 232
LED 3 (red)	System is connected to the computer via USB	Data being transferred

Installation

Connections of the AS 281 All-In-One

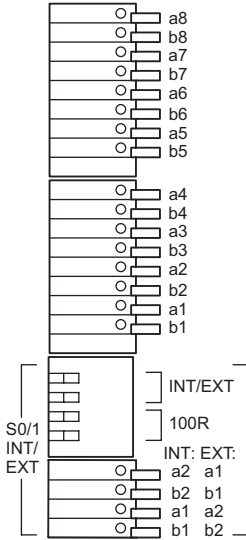

Note with reference to DIP switches:

The DIP switch settings for the S0 Busses are as follows:
 Towards PCB: Switchable S0 Bus is set to internal
 Away from PCB: Switchable S0 Bus is set to external

The DIP switch settings for the termination resistors are as follows:

Towards PCB: Termination Resistor is set to ON
 Away from PCB: Termination Resistor is set to OFF

analogue extensions

switchable S0s

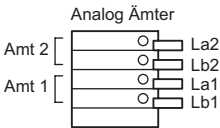

analogue lines

Installation

Connections of the AS 35

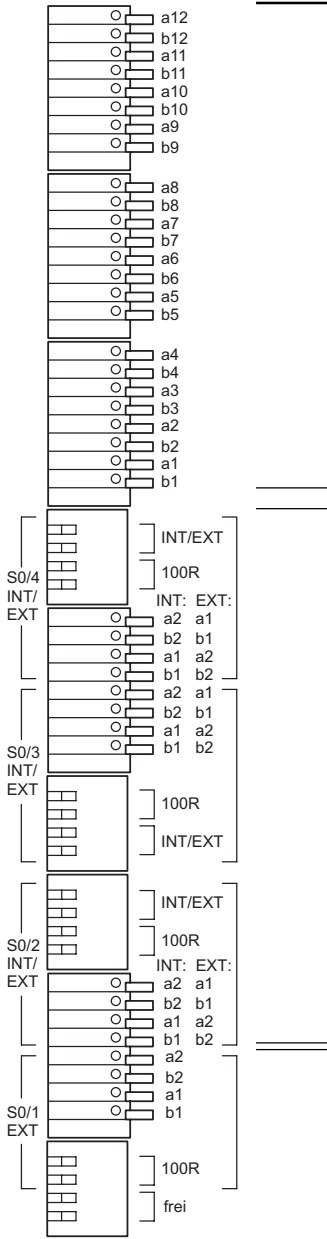

Note with reference to DIP switches:

The DIP switch settings for the S0 Busses are as follows:
 Towards PCB: Switchable S0 Bus is set to internal
 Away from PCB: Switchable S0 Bus is set to external

The DIP switch settings for the termination resistors are as follows:
 Towards PCB: Termination Resistor is set to ON
 Away from PCB: Termination Resistor is set to OFF

analogue extensions

switchable S0s

external S0

Installation

Connections of the AS 35 All-In-One

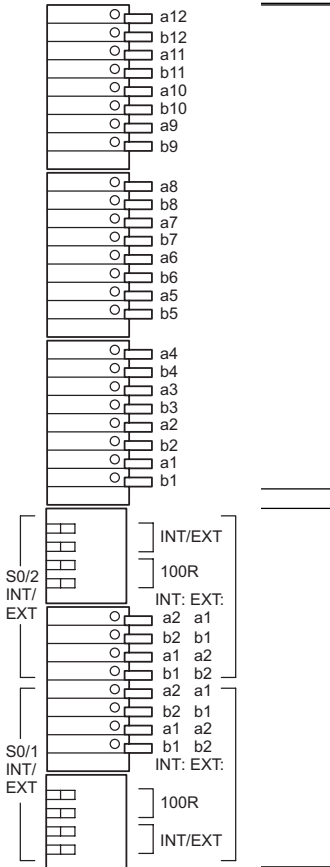

Note with reference to DIP switches:

The DIP switch settings for the S0 Busses are as follows:
 Towards PCB: Switchable S0 Bus is set to internal
 Away from PCB: Switchable S0 Bus is set to external

The DIP switch settings for the termination resistors are as follows:
 Towards PCB: Termination Resistor is set to ON
 Away from PCB: Termination Resistor is set to OFF

analogue Extensions

switchable S0s

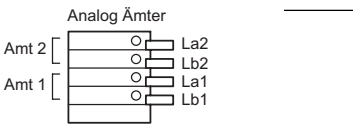

analogue lines

Installation

Connect Analogue Extensions

You may connect any analogue apparatus to the system which has been approved for connection to the public switched telephone network.

a/b-Apparatus is:

- Telephone (2 wire Phone or POT) either LD or MF Dialling with Timed Break Recall (TBR) (60 – 800 ms)
 - LD Phones may only have limited feature access.
 - Fax machines Group 3
 - Telephone Answering Machines
 - Modem 56k (V.90 to 56600 bps, may reduce to 33600 bps due to quality of lines V.34+)
- Connect the analogue apparatus via 2 wires to the a and b wire (Speech Pair) of the system port

Connection of wire

- Strip the cable by 11 mm.
- Push the single wire all the way into the connection block without pressing the release catch.
- To disconnect a wire, press the release catch with a small screwdriver while at the same time pulling out the conductor

External S0-Connection Fixed S0

System Access Connection

You can only connect a telephone system to a system access connection or also known as point to point connection. Other ISDN devices cannot be connected. The system can be connected directly to the NTTP via the enclosed ISDN Cable. You can also connect to a socket which is then connected to the NTTP.

Termination Resistors for the external S0 Connection

Both switches for the 100 Ohm Termination Resistors must be set to on for the System Access Connection.

Standard Access Connection

A Point to Multi Point connection may be installed as a S0 Bus type and up to 12 ISDN Sockets can be connected to this. The telephone system and up to seven additional ISDN devices may be connected to the S0 Bus.

Termination Resistors for the external S0 Connection

Both switches for the 100 Ohm Resistors must be set as follows:-

- **closed or on** if the connection is made directly onto the NTTP or on the last socket which has no 100 Ohm Termination Resistors fitted.
- **open or off** if the last socket has the 100 Ohm Termination Resistors installed or if the telephone system is not the last ISDN device on a PTMP line.

Connect the phone system directly with the ISDN connection cable to an ISDN socket of the S0 Bus or to the NTTP if the installation has no S0 Bus option.

Installation

Switchable S0 Connections (internal or external S0-Connection)

External S0-Connection

You may connect the external S0 Connection to a System Access (PTP) or Standard Access (PTPM) line. Please refer to External S0 Connection (RJ45 Socket).

Use the enclosed ISDN Cable and connect the four wires to the S0 connection block of the module.

- Push the wire all the way into the connection block without pressing the release catch.
- Connector: a1 -green
 b1 -brown
 a2 -yellow
 b2 -white

- To disconnect a wire, press the release catch with a small screwdriver while at the same time pulling out the conductor.
- Guide the cable through the cable comb.

Termination Resistors for the external S0 Connection

System Access (PTP) –Both DIP Switches (Page 1-7/8) for the 100 Ohm Resistors must be closed or set to on. (Default Setting)

Standard Access (PTMP) - Both DIP Switches (Page 1-7/8) must be

- **closed or set to on** if the connection is made directly onto the NTPP or on the last socket which has no 100 Ohm Termination Resistors fitted.
- **open or set to off** if the last socket has the 100 Ohm Termination Resistors installed or if the telephone system is not the last ISDN device on a PTMP line.

Plug the ISDN Plug into the ISDN connection after completion of all installation work.

Installation

Internal S0-Connection

You can connect up to 8 ISDN devices like on a PTMP connection on the internal S0 Bus of the System.

ISDN Apparatus:

Digital AGFEO System Phones (max 2 digital phones per S0 Bus)

-ISDN -Telephones

-ISDN -PC-Cards

-ISDN -Fax machines

Up to four ISDN devices without additional power may be connected. For example: 4 ISDN Telephones or 2 Digital System Phones plus 2 ISDN Telephones.

Connections of further ISDN devices will need their own power source.

ISDN Apparatus must use the DSS1 protocol.

You will need the following material to install an internal S0 Bus.

Telephone wire CW1308 (minimum 2 pair) or CAT5 Cable

RJ45 Sockets max. 12 per Bus

2 Termination Resistors, 100 Ohm 0.25 W

Maximum S0 Bus length will be 130 m. (Telephone System to last RJ45 Socket)

Termination Resistors for the Internal S0 Connection

The internal S0 Bus must be terminated. Install two 100 Ohm Resistors in the last RJ45 Socket (See Diagram). Both DIP Switches must be closed (or set to on)

Colour Code for Telephone Cable CW1308

S0 Bus	Contact	Colour
a1	4	Blue/white Bands
b1	5	White/Blue Bands
a2	3	White/Orange Bands
b2	6	Orange/White Bands

Colour Code for T568B (CAT5)

S0 Bus	Contact	Colour
a1	4	Blue/White
b1	5	White/Blue
a2	3	White/Green
b2	6	Green/White

Colour Code for T568 A (ISDN)

S0 Bus	Contact	Colour
a1	4	Blue/white
b1	5	White/Blue
a2	3	White/Orange
b2	6	Orange/White

Most common used standard for S0 Bus installation is T568B (CAT5)

Ensure that pairs are not mixed up.

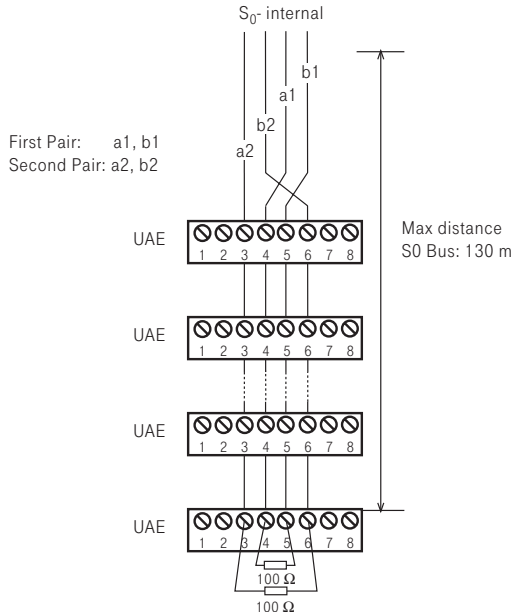

Installation

Connect the AS 281 All-in-one/ AS 35 All-In-One to an analogue exchange line

- Connect each wire of the line cord to the relevant port of the AS 281 All-In-One / AS 35 All-In-One.
- Connect the plug to the socket of your telephone provider.

Please note that in difference to the ISDN line the analogue exchange line is unable to send call progression. As such the calling party will not receive a confirmation from the telephone network if the called party has answered. Therefore there will be the following difference between analogue - and ISDN line.

- From the time the exchange line has been seized by the relevant extension will be the time the call will be logged as to have started, even if the called party is busy or does not answer.
- MF overdialling is possible but will not be recognised by the system as such. This will result that the dialled telephone number including overdialled number will be stored in the call log and last number redial.

Installation

Door Phone

It is possible to connect a door phone to the extension port of the telephone system. This analogue door phone will receive the control signals as DTMF tones. To use such a door phone you must set the relevant extension port to door using TK Suite, section "System Telephones", drop down menu "Phone Type".

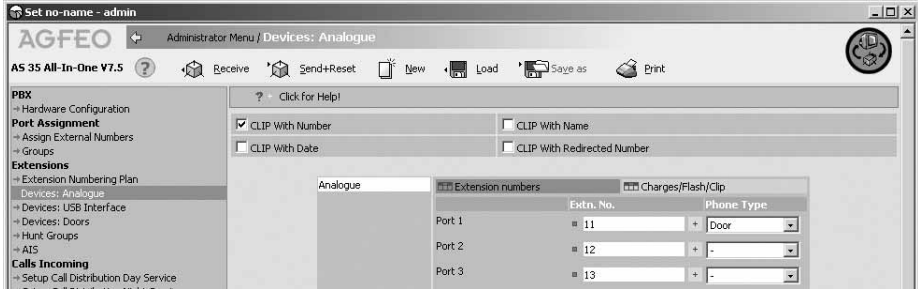

In addition you must assign an extension number for the relevant bell push buttons. This setting you will find under "Doors". Up to 4 Bell Push Buttons are supported for one door phone. After this you would have to set the relevant DTMF digits to operate the door phone, these you will find in the user manual of the door phone.

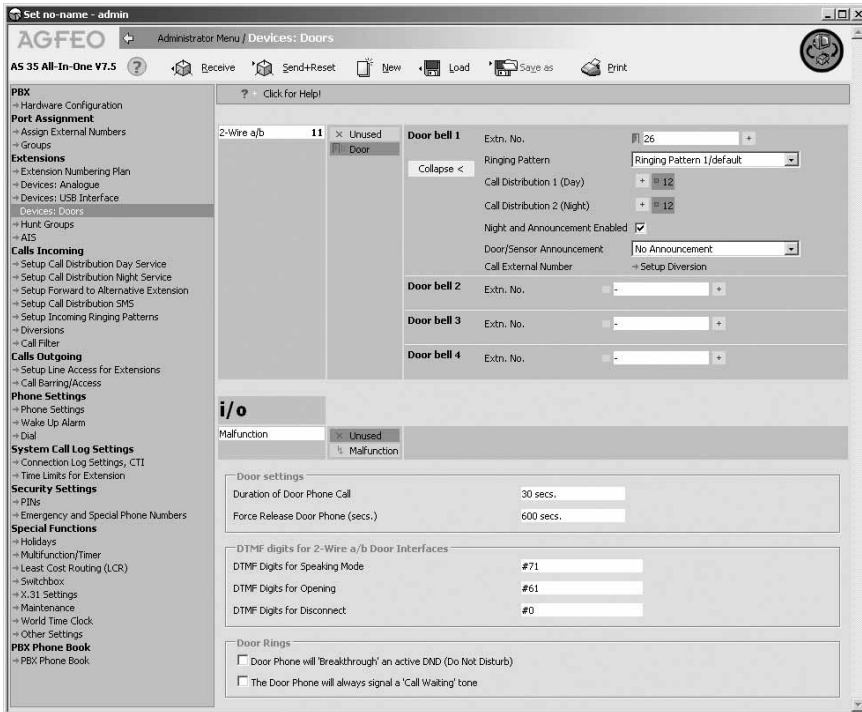

Installation

Commissioning

You have installed the system. However, before you can make a call you must do the following:

- Connect the extensions. You may connect any apparatus which you are allowed to connect to the public switched telephone network.
- Connect the RJ 45 plug to the ISDN network or connect the relevant connection cable to the analogue network. (Analogue Network AS 35 All-In-One only)
- Switch on the telephone system by plugging the mains plug into the mains socket.

Programming to the users requirement can be carried out via the connection of a PC. The remote programming of the system may be carried out via your dealer.

Notes

To avoid calling wrong telephone numbers please ensure that the following is carried out. After installation of the system please dial from an analogue MF telephone a single digit, this ensures that the system recognises the correct dialling method for the relevant extension. Should you change to a telephone which is dialling in LD, then you must dial a digit higher than 2. Should you operate two telephone on one port, then you must ensure that both phones connected are of the same dialling method.

Installation

Default Settings

Listed below are the default settings:

AS 35

- The Termination for external S0 Connection is closed, the 100 Ohm terminating resistor is switched on
- Switchable S0 connection S0-2: set to external, the 100 Ohm terminating resistors are on
- Switchable S0 connections S0-3 and S0-4: set to internal, the 100 Ohm terminating resistors are on

AS 281 All-In-One and AS 35 All-In-One

- Switchable S0 connections S0-1 and S0-2: set to internal, the 100 Ohm terminating resistors are on

Both Systems

Extensions: 11, 12, 13, 14, 15, 16, 17, 18, 19, 20

All users set to: Telephone

External line access: unrestricted for all extensions

Line access with 9

Day Service 1 no entry

Night Service 2 no entry

Call diversion internal: off

Do not Disturb: Off for all extensions

Call waiting: off for all extensions

transmission of own number to called and calling party: set to on

Music on Hold: Internal off

Automatic dialling: off

Printing of call records: off for all extensions

Printing of dialled phone number: without

Cost limit: No entry

Charge unit factor: 0,061

Base factor: 0,061

Disconnect on Cost limit: off

Program access code: off

Switchbox number: no entry

Busy on Busy: off

Prefix 0 to call from call log via internals S0 connection: off

System Phones:

-Display Call Charges:off

-Display:english

-Call Log:off

-Pop Up Menu : on

Installation

Technical Data AS 281 All-In-One

Specification	ISDN Telephone System with 2 external analogue lines
Basic Configuration	1 S0 connections switchable internal / external 8 Analogue Extensions (POT's)
Measurements	8,1 x 32,2 x 24,4 cm (High x Width x Depth)
Weight	1,6 kg
Ambient temperature - Operation/Storage	5 °C bis 40 °C / -25 °C bis +70 °C
Humidity	max. 70 % (none condensing))
Mains Connection - Power Consumption	230 VAC, +/-10%, 50 Hz $P_{\max} = 35 \text{ W}$
Switchable Connection	S0 connection internal / external switchable (DIP Switches) external: PTP or PTMP connection Euro ISDN 2e (DSS1) internal: PTMP connection, Euro ISDN 2e (DSS1)
- Connection	4 wire spring loaded connectors
- Length	max length of internal S0 Connection: 130 m
- Power Consumption internal S0	4,5 Watts
- ISDN-Apparatus	max. 8
Analogue Apparatus	max. 8
- Distance	2 x 50 Ohm (\varnothing 0,6 mm, 800 m)
- Connection	2 wire spring loaded connectors
- Dial Method	DTMF or LD
- Enquiry Button	Flash (80 - 600 ms)
PC/ Printer Connection	RS 232C
- Range/ Level	3 m / +/- 5 V
- Connector	9 pin D-socket
USB Connection	Universal Serial Bus
- Cable Length	3 m

Installation

Tecnical Data AS 35

Specification	ISDN Telephone System
Basic Confioguration	1 external So Connection (PTP or PTMP) 3 SO connections switchable internal / external 12 Analogue Extensions (POT's)
Measurements	8,1 x 32,2 x 24,4 cm (High x Width x Depth)
Weight	1,6 kg
Ambient temperature - Operation/Storage	5 °C to 40 °C / -25 °C to +70 °C
Humidity	max. 70 % (none condensing)
Mains Connection - Power Consumption	230 VAC, +/-10%, 50 Hz $P_{max} = 35 \text{ W}$
External S0 Connection fixed	PTP or PTMP connections, Euro ISDN 2e via RJ 45 Socket and enclosed connection cable
Switchable Connection	SO connection internal / external switchable (DIP Switches) external: PTP or PTMP connection Euro ISDN 2e (DSS1) internal: PTMP connection, Euro ISDN 2e (DSS1)
- Connection	4 wire spring loaded connectors
- Length	max lenght of internal S0 Connection: 130 m
- Power Consumption internal S0	4,5 Watts
- ISDN-Apparatus	max. 8
Analogue Apparatus	max. 12
- Distance	2 x 50 Ohm (diam. 0,6 mm, 800 m)
- Connection	2 wire spring loaded connectors
- Dial Method	DTMF or LD
- Enquiry Button	Flash (80 - 600 ms).
PC/ Printer Connection	RS 232C
- Range/ Level	3 m / +/- 5 V
- Connector	9 pin D-Socket
USB Connection	Universal Serial Bus
- Cable Length	3 m

Installation

Technical Data AS 35 All-In-One

Specification	ISDN Telephone System with 2 external analogue lines
Basic Configuration	2 S0 connections switchable internal / external 2 external analogue lines 12 Analogue Extensions (POT's)
Measurements	8,1 x 32,2 x 24,4 cm (High x Width x Depth)
Weight	1,6 kg
Ambient temperature - Operation/Storage	5 °C bis 40 °C / -25 °C bis +70 °C
Humidity	max. 70 % (none condensing))
Mains Connection - Power Consumption	230 VAC, +/-10%, 50 Hz $P_{\max} = 35 \text{ W}$
Switchable Connection	S0 connection internal / external switchable (DIP Switches) external: PTP or PTMP connection Euro ISDN 2e (DSS1) internal: PTMP connection, Euro ISDN 2e (DSS1)
- Connection	4 wire spring loaded connectors
- Length	max length of internal S0 Connection: 130 m
- Power Consumption internal S0	4,5 Watts max. 8
- ISDN-Apparatus	
Analogue Apparatus	max.12
- Distance	2 x 50 Ohm (\varnothing 0,6 mm, 800 m)
- Connection	2 wire spring loaded connectors
- Dial Method	DTMF or LD
- Enquiry Button	Flash (80 - 600 ms)
PC/ Printer Connection	RS 232C
- Range/ Level	3 m / +/- 5 V
- Connector	9 pin D-Socket
USB Connection	Universal Serial Bus
- Cable Length	3 m

Operation

System Phone ST 40

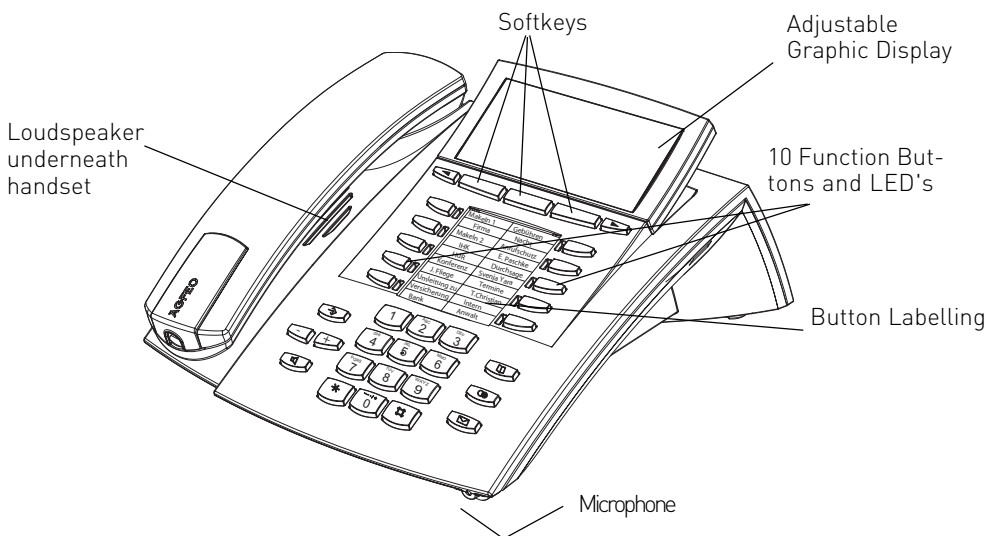



  Numeric Keypad

  * and # Buttons

 Set Button - Start and end programming. Keep this button pressed to toggle between programming tree and programming index

 Handsfree Button - Activates the Loudspeaker. Button lights up when activated.



  Arrow Buttons - To scroll through the display where there is more than one function.

 Phone Book Button - Retrieval of Telephone Numbers.

 LNR - Last Number Redial Button. Keep this button pressed to show call log.

 Mail Button - Flashes on new entry in call log or missed calls. Stays lit for numbers already viewed. Clears when number is called or deleted from list by pressing clear button

 10 function Buttons - User programmable, two entries per Button (First & Second Level) Keep this button pressed for approx 1 sec. to show the second level. LED indication only for first level.

  Plus and minus for volume control of handset and speaker.

 Softkeys: The function for these buttons are shown in the display above. Function offered are depending on the relevant phone status.

Operation

Display of the ST 40

Display in standby:

Internal and external S0 Status, one box per S0.

Extensions off hook. Called extension will be shown inverted.

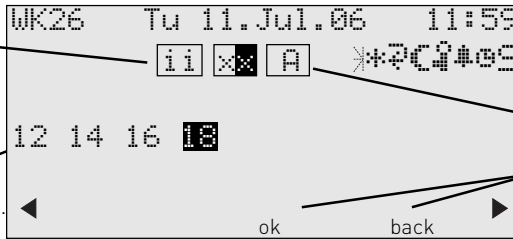

Activated features are shown here

Status of analogue trunk lines

Current function of soft key below.

1. Display Line: Date / Time

Index of functions:

⊗ External ISDN-Line. One line (a B-channel) is busy. The "x" is shown inverted on an external call.

i Internal ISDN-Line. One Line (a B-channel) is busy.

A Analogue trunk line. The "A" is shown inverted on an external call

Features:

Browse with ◀▶, Confirm with „ok“

⌘ Call-Waiting off

* Do Not Disturb on

☎ Diversion/ISDN-call forwarding active

€ CVA 2 (Night service) on

🔒 Phone lock on

Wake-up on

🕒 Appointment on

S Sensor activated

F Filter activated

I Withhold own number

PC PC Programming in process

Menu Guidance

Please look at the display when using the telephone as it will guide you through all operating procedures. Depending on its operating condition the following soft keys are offered:

Answer, Park Call, Retrieve, Get, Split, Transfer, Call Back. Conference, Recall, Reject, Disconnect, Go To, Back, End, OK, on, off, Store and Door Opener.

Operation

Notes on using this Manual

The highlighted bar above each instruction will indicate if the setting procedure is for the ST 40, Analogue- or ISDN telephone.

The soft keys below the phone display will be indicated by this symbol. 

The relevant button which is to be pressed will be shown in black.

Please observe the display area if no black button is indicated. Should there be more than three options, then the most used function will be shown first. More functions can be selected by pressing the arrow buttons.

System Telephones - Settings

You can alter the following settings on your System Phone:

- Tone Ringer - Volume and Pitch
- On Hook / Handsfree Volume
- Handsfree microphone – Automatic activation on Voice Alert
- Headset and Handset Volume
- Telephone Lock – Your Phone will be barred from making calls
- Display of call charges
- Status display (Extensions and Lines) and or Date & Time
- Set Call Log
- Set access to outside line -direct or with access digit

Setting of Date & Time is done by the ISDN Network (Not available from UK Network Providers)

Setting the Ringing volume

ST 40

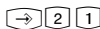

Alter the Ringing
Volume

 1 -very low
7 -very high

Enter digit



Exit Programming

Your phone will ring at the newly set value.

Setting the Ringers Pitch

ST 40

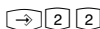

Setting the Ringers
Pitch

 1 - Tone 1
7 - Tone 7

Enter digit



Exit Programming

Your Phone will now ring with the selected pitch.

Operation

Setting the Speaker Volume

ST 40

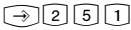

Setting the speaker volume

1 - very high
7 - very low

Enter digit



Exit Programming

Setting the Receiver Volume

ST 40

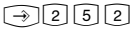

Setting the Receiver Volume

1 -very low
7 -very high

Enter digit



Exit Programming

Setting the Headset Volume

ST 40

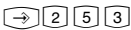

Setting the Headset Volume

1 -very low
7 -very high

Enter digit



Exit Programming

Cost display

ST 40



Setting of cost Display



Switch on or off



Exit Programming

Please note that this service may have to be requested from your network provider as indication of call charges during or at the end of a call. (This service is not available from the UK network providers)

Setting S0 Status Display

ST 40

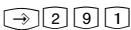

Setting S0 Status Display



Select a free space in the display with arrow buttons



Select the S0 whose status is to be displayed with arrow buttons



Exit Programming

Setting Extension Status Display

ST 40

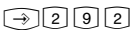

Setting Extension Status Display



Select extension whose status is to be displayed with arrow buttons



Exit Programming

Operation

Set Extension Number for your Telephone

ST 40

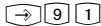

Set Extension Number



Enter Extension
number



exit programming

Instant Dialling On/Off

ST 40

Your System Phone can be set so that the entered telephone number will go to line after the receiver is lifted or your phone will go off hook (handsfree mode) as soon as you start to enter a telephone number.

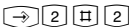

Setting for Instant
Dialling



Exit Programming

Operation

Button Assignment

On delivery of the Phone System all programmable function Buttons of the Phones have a default setting which are the same on all System Telephones. These Buttons can be individual programmed to suit your specific needs. Each of the 10 Buttons can have a function allocated to it, which you can activate by just pressing the Button. In addition each of the function Buttons have a second level. To activate the second level you must hold the function Button pressed for 1 second.

Default Setting:

Announce System Memory	Call Waiting System Memory
Appointment System Memory	Tone Call System Memory
Call Filter System Memory	Mute System Memory
System Memory	Diversion to System Memory
System Memory	Internal System Memory

Changing Button Assignment

ST 40

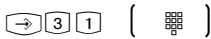

Start Programming Enter PIN if prompted



Press Button, you want to assign



Enter the first letter of the function 's name, or choose the function with arrow buttons



Confirm selection



End Programming

Operation

Function Buttons - Freely programmable Function Buttons (overview)

TAM activation	To switch TAM module on or off of the ST 30 System Phone.
TAM info	To listen to messages recorded on the TAM.
TAM Memo	To record messages on the TAM
Reject	Reject the ringing call. Caller will hear busy tone.
Call Waiting Enabled / off	You can select if: If the caller will get busy tone if on a call. (off) If a waiting call should only be visually indicated on your phone. Or if a call waiting tone should be signalled. (audible)
Call Deflection	To divert an incoming call during the ringing phase. There will be no change to the ringing tone when diverted. The caller will not be aware that the call was forwarded.
Call Filter	To switch Call Filters on or off.
Call Log	Will list the Call Log
Cleaning	In connection with the check in / check out button. This can be used to signal to the front desk that a room has been cleaned and is ready for occupation.
Do not Disturb (DND)	This will disable the Tone Ringer Special function buttons may be set: DND for internal calls DND for external calls DND for internal- and external calls.
Night Service (AVA 2)	Night Service on or off. Special function buttons may be set: Night Service can be switched for each trunk line. Night Service can be switched for all trunk lines.
Call Forwarding	Enable / Disable Call Forward if designated extension does not answer on incoming call. Special function buttons may be allocated: Switch Call Forward for each trunk line. Switch Call Forward for all trunk lines.
Tannoy	Announcement via Public Address Amplifier connected to the Telephone System
Busy on Busy	Return Busy Tone to Caller if one Extension is Busy within Call Distribution Group. Special Buttons can be assigned -Busy on Busy for each Call Distribution Group switchable separately -Busy on Busy for call Call Distribution Group switchable together
Call by Call	To select Network Provider via LCR
Check In/ Check Out	Check in / Check out for Hotel applications. Will start and stop call logging and switch on or off trunk line access.
Page (Tannoy)	Pageing Announcement to System Phones. Programmable function Button - Page specific Extensions.
Units	Display Call Cost
Call Capture	Malicious Call Identification via ISDN-Exchange
Remote functions	Sending of stored DTMF Tones (1..0 * #) for a remote interrogation of a Telephone Answering Machine (TAM)
Remote Answer	Possible to make the ringing extension go off hook from another phone.
Group Button	Log in and out of Groups and their features
Headset	To use a Headset (only Digital System Phones)
Mute Button	To mute microphone on your telephone.

Operation

Function Buttons - Freely programmable Function Buttons (overview)

Call Pick Up	To Pick Up incoming calls. Special Function Button can be assigned to Pick Up internal and external calls from specific extensions.
Withhold	To withhold own number to be sent to a called party.
Internal Button	To Dial Extensions. Special function Button programmable: Call specific Extension
ISDN-Hold	To Hold an external call in the Telephone Exchange (only available on PTMP connection)
ISDN-Call Forwarding	To switch on or off the ISDN Call Forwarding feature.
Conference	To set up a Coneference Call with Internal and or External calls.
Speaker Volume	To set the Speaker Volume Level for Handsfree or On Hook use.
LCR	To switch Least Cost Routing (LCR) on or off for your System Phone.
Call Split	To talk to more then one External Call in turn. (Switch between them)
Brokers Call	To talk to one internal and one external call at a time and without connecting them.
External	To transmit another of your MSN numbers other the the one allocated to the Extension making the call. A special Button can be assigned for this feature.
Relays	To switch a Relays. A special function Button can be assigned.
Reserve	To reserve a line should all lines be engaged at the time.
Sensor	To Enable or Disable Sensors.
SMS info	Will list all saved SMS messages
Write SMS Message	To write new SMS message.
Enquiry Call	To establish or set up an Enquiry Call, a connection or a Brokers Call
Telephone Book	To select a number out of the System Telephone Book
Telephone Lock	To Lock the System Phone and activate pr-set Emergency and Direct Call numbers.
Appointment	To set or cancel a preset Appointment Time
Timer	To switch on or off a Time based function, such as Day-Night Service, Call Forwarding, Relays etc. Button can be assigned for this function. 10 Timers are available. Timers are form 0 to 9.
Doorphone and Lock Release	Function Button can be assigned to connect to the Doorphone. Another Button can be assigned to activate Lock Release.
Transfer	To transfer and connect an external call to an external call.
Diversion from (Follow me)	To divert all calls from another phone to the current phone used.
Diversion to	To divert all calls to another extension- or external number.
Wake Up	To Enable or Disable the set Wake up call..
Destination Button	To Call a preset Telephone Number
- Public	- This number is stored in the Telephone System Memory
- Private	- This number is only stored in your telephone

Operation

External Line Access

Depending on your preference the system offers different modes to connect to an outside line. Direct access will connect any number dialled to the exchange line.

To dial an extension you prefix the extension number with #. If your phone has no # button then you are unable to make any internal calls.

If you select the setting with access digit then you have to dial 0 (or 9) to get an outside line. In this case you would dial 9 and the required telephone number or the two digit extension number to make an internal call.

Setting direct access

ST 40

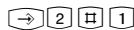

Setting direct access



activate or deactivate



exit programming

Setting external Seizure

Analogue and ISDN Phones



0 = direct access off
1 = direct access on



Lift receiver

Setting external Seizure

Set variant

Acknowledgement tone

Replace receiver

Operation

Making a Call

To make an internal call, pick up receiver and dial the extension number. Please contact your Telephone System Manager for an Internal Telephone Directory.

To make an exchange line call depends on how your telephone system is programmed.

For users who's extension is set to .Direct Access' just need to dial the the required telephone number. If you would like to make a call to another extension on your telephone system, then please prefix the extension number by #.

If a line access digit is set then you have to dial 0 (or 9 as the case may be) to get an outside line and then dial the telephone number required. If you would like to call another extension on your system, then just dial the two digit extension number.

If Call Forwarding is active on your line, then you will hear a special dial tone from the telephone exchange after you connect to the line. This will remind you that this or another feature may be set in the exchange

Operation

"Direct Access" activated

ST 40

Calling an internal user:



Lift receiver



Press the 'Internal or Intercom' Button and dial the required extension number.

Calling an external number:



Lift receiver



Just dial the telephone number required. The telephone system automatically seizes an outside line .

"Direct Access" activated

Analogue and ISDN Phones

Calling an internal user:



Lift receiver



Press the 'Internal or Intercom' Button and dial the required extension number.

Calling an external number:



Lift receiver



Just dial the telephone number required. The telephone system automatically seizes an outside line.

"Direct Access" deactivated

ST 40

Calling an internal user:



Lift receiver



Dial the Extension Number only

Calling an external number:



Lift receiver



Dial 0 (or 9 if applicable) to get a line. On hearing external dial tone dial required telephone number

"Direct Access" deactivated

Analogue and ISDN Phones

Calling an internal user:



Lift receiver



Dial the Extension Number only

Calling an external number:



Lift receiver



Dial 0 (or 9 if applicable) to get a line. On hearing external dial tone dial required telephone number

Operation

External Access with specific MSN

You may send another MSN number other than the one allocated to you to the network.

External Access with External Button

ST 40



Press Button
External



Select the phone number or name of the line you wish to access.



Dial the required telephone number

External Access with specific External Button

ST 40



Lift receiver



Press the MSN /external Button to seize an outside line. Line name and number may be displayed.



You now will hear external dial tone and can dial the number required.

External Access with specific MSN

Analogue and ISDN Phones



Lift receiver



prepare external dialling



enter specific MSN



terminate entry



enter external phone number



conduct call

Reserving an Outside Line

On requesting an outside line you will hear busy tone if all lines are engaged. You may now request for a line to be reserved. As soon as an outside line becomes free the system will phone you back. When picking up the receiver you will hear external dial tone and can dial your number.

Reserving an Outside Line

ST 40

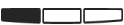

On hearing busy tone while dialling number press the left Button to reserve an outside line.



replace receiver



The Telephone System will call you back as soon as a line becomes available.



Pick up Receiver, you will hear external dial tone



Dial required number

Operation

Reserving an Outside Line

Analogue and ISDN Phones

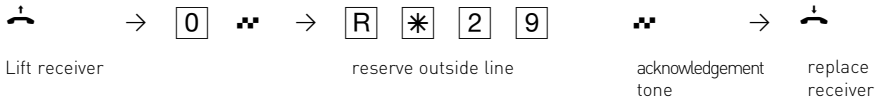

Notes

Barred Calls – You will not be able to make calls for which your extension is call barred. If you try and make a call to a barred number, error tone will be returned to you.

DTMF signalling -Is possible to send DTFM Tones during a connection. This can also be done during an enquiry call, Brokers Call and Three Party Conference. Any digit from 0 – 9 including * and # can be transmitted.

Prepare for dialling -The receiver is on the hook. Enter the phone number.The number entered is displayed. The call will be connected as soon as the receiver is picked up or the handsfree button is pressed.

On Hook Dialling-Press the “loudspeaker ” button and dial the phone number.Lift the receiver once the other party answers.

Handsfree -Instead of lifting the receiver, you can also press the “loudspeaker ”button and have a handsfree telephone conversation. Handsfree mode is turned off when you pick up the receiver. To switch to handsfree again press the speaker button before you replace the handset. To end the call press the speaker button.

Call Monitor – Press the speaker button if you want other people in the room to hear your telephone conversation. People in the room can listen to the other party via the speaker while you continue your call as normal.

Operation

Accepting Incoming Calls

Due to a different ringing you are able to differentiate between extension -, incoming and doorphone calls. You can also see who is phoning you before you answer the call.

You are called

ST 40

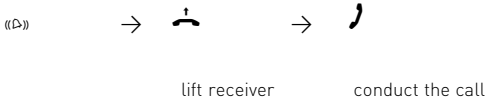

You are called

Analogue and ISDN Phones

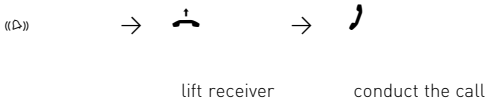

Call Waiting

You can receive a second call while already on a call. If this happens you will hear a Call Waiting tone in your receiver. You can accept or reject the waiting call.

Call Waiting

ST 40

1. Possibility:

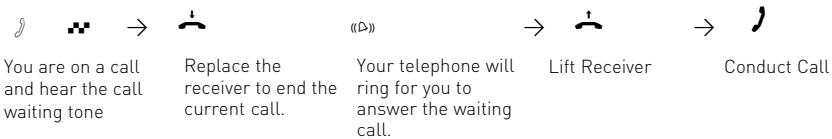

2. Possibility:



Press the Split Button. The first call is placed on hold while the waiting one is connected to you. You can alter between the calls by pressing the Split Button. You can also deflect the waiting call.

Operation

Call waiting

Analogue and ISDN Phones

1. Possibility:



 End the call

«(P)»



Automatic ringing by the waiting party

 Lift the receiver



 Conduct the call

You are on a call and hear the call waiting tone

2. Possibility:



 Press R the call is placed on hold



 Answer the waiting call



 conduct the call

You are on a call and hear the call waiting tone

Reject the waiting call

ST 40



Press the Reject Button. The caller will now hear busy tone if you are the only phone programmed to ring on an incoming call. If there are also other phones programmed to ring on an incoming call then the caller continues to hear the ringing tone.



Continue your original call.



Reject the waiting call

Analogue and ISDN Phones



 Press R the call is placed on hold



   Reject the waiting call



 Continue your call

You are on a call and hear the call waiting tone

Notes

If you hear error tone when trying to answer a waiting call, then the call waiting tone is for the other party.

The call waiting tone can be switched off by setting .Call waiting deny

Operation

Call Transfer

You can transfer an incoming call to an extension or another external number. When transferring a call to an extension you can announce the caller before replacing the receiver.

Internal Transfer with announcement

ST 40



If you are on an external call and would like to transfer this to an extension

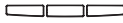

press "Enquiry" and dial the required extensions



The extension answers, announce the call and replace the receiver.

If the extension does not answer, press "back" to get back to the external call. You may transfer the call to another extension.

Internal Transfer with announcement

Analogue and ISDN Phones



Conduct external call

enquiry, external call is placed on hold

Enter internal phone number

Announce external call

transfer external call

Internal Transfer without announcement

ST 40



If you are on an external call and would like to transfer this to an extension

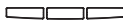

press "Enquiry" and dial the required extensions



The called extension is connected to the transferred call as soon as the receiver is picked up.

The call will also be returned to you if the extension has not answered the call within 45 seconds. Ringing of your extension will be cancelled if you fail to answer the returned call within 60 seconds.

Operation

Internal Transfer without announcement

Analogue and ISDN Phones

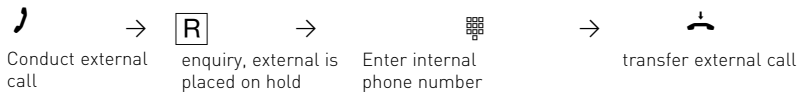

External Transfer

ST 40

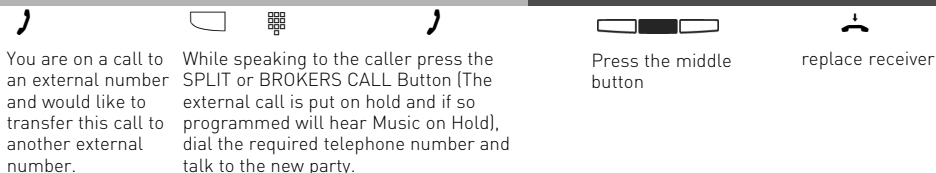

If the called Party does not answer, press to get back to the call placed on hold.

External Transfer

Analogue and ISDN Phones

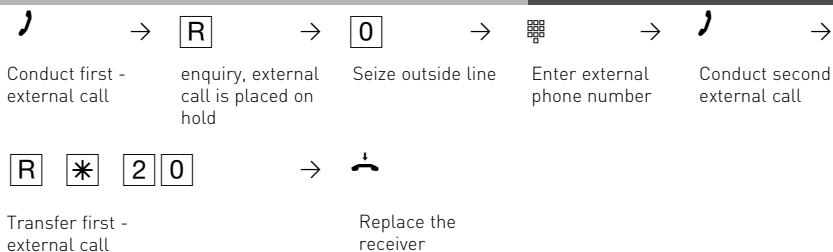

Notes

When transferring an external call, you must always seize the outside line by entering „9“, even if spontaneous outside line seizure with internal is set on the telephone.

External Transfer is only possible if a dial-up line (B-channel) is free.

You bear the cost of the externally transferred call.

A user on the internal S0 bus can only forward an external call internally if the second B channel of the internal S0 bus is free. External/external Transfer is not possible.

Operation

Transfer an Outside Line

You can give an extension an outside line. This is useful in cases where the extension is not allowed to make outside calls. The extension can phone the system operator who can transfer a line. Note you will transfer a line with your Class of Service.

Transfer an Outside Line

ST 40



Extension calls you and asked for an outside line.



Press the Brokers Call Button or the Split Button



Press "transfer".
The calling extension can now make an outside call.

Call Waiting/ Callback when free

A extension already on a call will hear a call waiting tone in their handset when you call it. If the called extension replaces the receiver then the waiting call will ring immediately at this extension. You can initiate Call Back when Free if the called extension does not accept your call.

Requesting Ring back when free

ST 40



On hearing the busy tone when calling an extension.

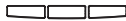

Press Softkey "Recall". Ring back when free is initiated



Replace Receiver

Requesting Ring back when free

Analogue and ISDN Phones



Lift receiver



dial internal number



busy tone



Enquiry

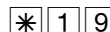

Request Ringback when free

Call waiting announcement - You cannot announce yourself as a waiting caller to an internal user

- from whom a callback is already expected.
- whose connection is set to the answering machine, fax, modem or combined unit terminal type,
- who has activated call waiting protection on his telephone.

If you wish to repeatedly announce a waiting call to an internal user without placing a call on hold, you must announce your call again.

Callback - You can initiate several callbacks in succession (from every internal user)

You cannot initiate a callback from an internal user

- from whom another user is already expecting a callback,
- who has activated do not disturb on his telephone,
- whose connection is set to the answering machine, fax, modem or combined unit terminal type,
- who has activated call waiting protection on his telephone.

Callback from a user with a standard -telephone:

- The callback is cancelled after 60 seconds if you do not pick up the receiver.
- A callback is cleared automatically once it has been established.

Callback in general:

You have activated a callback:

- if you have activated do not disturb on your telephone, this is temporarily -cancelled.
- if you have set call diversion on your -telephone, the callback is not diverted.
- Power failure: initiated callbacks are cleared.

Call list - Callback from a user with a -system telephone:

- If you do not pick up the receiver, after 60 seconds your call is entered in the call list of the user's system telephone.
- If you are busy, your call is immediately entered in the call list.
- If the user picks up the receiver during his callback, your call is immediately entered in his call list.

You cannot use the „call waiting -announcement/callback/call list“ features on a combined unit (phone/fax).

Operation

Call Waiting

With the Call Waiting Function you can choose if

- the caller gets the busy tone.
- the waiting call is indicated visual.
- the waiting call is indicated audible (you hear the call waiting tone).

Call Waiting on/off

ST 40



"1" : Visual
"2" : Audible



Press "set" and button "Call Waiting".

Press SET to end programming

Call Waiting on/off (Feature Button)

ST 40



The receiver is on the hook. Press the Call Waiting Button to switch this feature on or off

Call Waiting Set Indication

ST 40



"1" : off
"2" : Visual
"3" : Audible



Initiate Programming

End programming

Call Waiting on/off

Analogue and ISDN Phones



0= off
2= Audible



Lift receiver

Call Waiting on/off

Confirmation tone

Replace Receiver

Operation

Call Pick Up

Another telephone rings with an external or an internal ringing tone. You can pick up this call on your telephone. You can also pick the call up if the answering machine has already answered it.

Call Pick Up (External)

ST 40

«(D)»



You wish to pick up an external call.

Lift receiver. Press left Softkey. You are now connected to the caller.

Call Pick Up (External)

Analogue and ISDN Phones

«(D)»

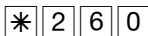

External call on - another telephone

Lift the receiver

Pick up external call

Conduct call

Call Pick Up (from Answering machine)

ST 40



Answering machine has accepted external call.



Lift receiver. Press button Call Pick Up. Only possible if button Call Pick Up is configured to extension number of TAM.

Call Pick Up (from Answering machine)

Analogue and ISDN Phones

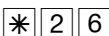

Answering machine has accepted external call

Lift the receiver on your telephone

Pick up

Enter the answering machine's internal phone number

Conduct external call

Operation

Pick Up a door call

Analogue and ISDN Phones

«(P)»



Pick up a door call on another extension

Lift the receiver on your telephone

Pick up door call

Doorphone Number

Conduct call

Call Log

If a call is not answered, then the details of the caller are entered in the Call Log. Details such as Date, Time, Telephone Number and the number of times called are recorded. If the calling number matches an entry in the Phone Book, then the Phone Book entry ie the stored name is displayed instead of the number. Internal calls can enter themselves in the Call Log. Up to a maximum of 10 entries can be made, if more entries are received then the oldest one will be deleted. A stored number will only appear once in the Call Log. If the caller rings more than once then the time of the last call is recorded in addition to the number of times called. Entries in the Call Log are stored until the call is returned or until the entry is deleted. Calls can be returned from the Call Log by the push of a button. If a call is returned from the Call Log, then the entry will be deleted automatically from the list. The Call Log can be switched on or off separately for external and or internal calls.

Call Log on/off

ST 40

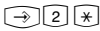

"set 2*" to set the call log



"1" = external

"2" = internal

make selection



"1" = off

"2" = with number

"3" = from Phone Book



toggle on /off



End programming

The following options will be offered if "external" has be selected:
off

with number: all calls will be logged. If the number is matched in the system phone book, then the name as stored in the phone book will be displayed.

from Phone Book: Only calls which are entered in the Phone Book will be logged.

Operation

Display Call Log

ST 40

The flashing mail button will indicate that there is one entry in the call log. With the receiver on hook press the mail button. The last missed call will be displayed giving telephone number, date and time. The LED will continue to be lit until you return the call or delete the entry from the call log.

You can use the arrow keys to view further entries. 

The displayed number will be dialled as soon as you lift the receiver. The entry will be automatically being deleted if the caller answers. The entry will remain in the call log if no one answers.

Delete the displayed entry by pressing the left button.

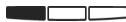

Abort the call log by pressing the right button.



Notes

The telephone number will be entered with the STD code in the call log. Therefore it might be possible that you are unable to return the call from the call log if are only authorised to make local calls only.

The log will be deleted in case of power fail.

Operation

Do Not Disturb

You can set Do Not Disturb for the first or second internal number of your extension and also for internal and or external calls. If an extension is ringing you while this feature is set then busy tone will be returned. External calls will not ring your phone.

Programming the Do Not Disturb function

ST 40



- "1": Do not Disturb for Internal Calls
- "2": Do not Disturb for External Calls
- "3": Do not Disturb for Exernal and Internal Calls



Press Set and button **"Do not disturb"** to start programming

Exit Programming

Switch Do Not Disturb on/off

ST 40



With receiver on hook press the Do Not Disturb Button. If Do Not Disturb was enabled, it will be switched off, if it was disabled, it will be switched on.

Switch Do Not Disturb on/off

Analogue and ISDN Phones



- 1 = internal calls
- 2 = external calls
- 3 = all calls
- 0 = off



Lift receiver

Do not disturb for

Define call type

Acknowledgement tone

Replace receiver

Notes

If Do Not Disturb is activated:

- External Calls are indicated in the Display only but can be picked up.
- You can still make calls. When you pick up the receiver, the special dial tone will remind you that Do Not Disturb is set to on.
- Your telephone will still ring for callback, wake up - and appointment calls.

You can program several special DO NOT DISTURB function Buttons. You can program a , DO NOT DISTURB function button for your first, second or both first and second internal numbers. In addition you can set this function for internal, external or all calls. (See allocation of function buttons)

Operation

Switching between Day and Night Service

Which extension should ring on an incoming call is set in the 'Call Variant' under Day/Night Service. If several extensions ring on an incoming call then the one who picks up the receiver first will have answered the call.

An incoming call can ring different extensions depending if the system is running under Day or Night Service.

Night Service can be set for each incoming line separately.

Day – Night Service can be activated from any extension on the system or remotely. Please refer to the operating instruction for an analogue phone on how to switch Day- Night Service from an external phone.

Set Night Service Function button

ST 40



Press SET and press the Night Service Button



Press Arrow Buttons to select the line or name to which Night Service should apply. Press ALL if you want to activate Night Service for all incoming lines.



Save changes



Exit Programming

Night Service on / off

ST 40



With the receiver on the hook. Press the "AVA 2" (Night) Button. If a function button and line has been assigned permanently to your extension, then you can switch this line to Night Service by simply pressing the "AVA 2" (Night Button)



Select the line or name to which Night Service should apply. Press ALL if you want to activate Night Service for all incoming lines.



Toggle Night Service on or off by pressing the middle button.

Night Service on / off

Analogue and ISDN Phones

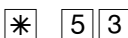

1 = on
0 = off
2 = all off
3 = all on



Lift receiver

Switch call variant 2

on / off:

Enter phone number to switch individually

Conclude input



Acknowledgement tone

Replace receiver

Operation

Night Service on / off from an external source

Analogue and ISDN Phones

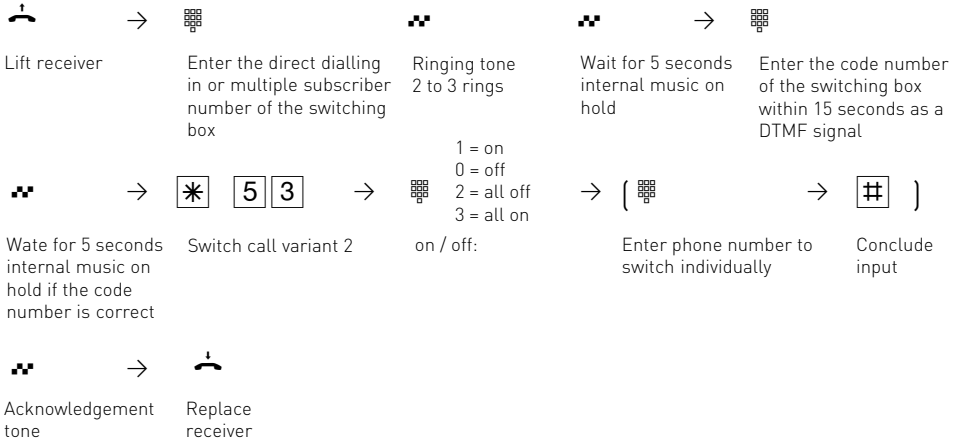

Notes

If the selection 'all off/all on' is set up when Night Service is switched on/off, door call variant 2 is switched on/off at the same time.

Operation

Switching Call Forwarding (Extension on Call Forwarding) on/off

With this setting incoming calls can be forwarded to alternative extensions if:

- after a preset number of rings the call remains unanswered.
- Immediately if the telephone is busy and call waiting indication is not possible.

This feature can be set at any time from any extension or remotely for any exchange line connected to your system.

Please refer to your user manual in the section 'Analogue Terminals' on how to activate this feature remotely.

The Call Forwarding is set for each extension in the programming table of the Call Forward section.

Set Call Forwarding Function button

ST 40



Press SET and the Call Forwarding Button



Press Arrow Buttons to select the line or name to which Night Service should apply. Press ALL if you want to activate Night Service for all incoming lines.



Save changes



Exit Programming

Switch Call Forwarding on/ off

ST 40



Press the "AVA 3" (Call Forward Button). If the Button is defined for one Line, Call Forward can be toggled on/off by pressing this button.



If the Button is not defined for one Line, choose the line for which you want to toggle Call Forward on/off.



Press middle button to toggle Call Forward on/off.

Switch Call Forwarding on/ off

Analogue and ISDN Phones



1 = on
0 = off
2 = all off
3 = all on



Lift receiver

Switch call variant 3

on / off

Enter phone number to switch individually



Acknowledgement tone

Replace receiver

Operation

Internal Call Forwarding on/ off from an external telephone

Analogue and ISDN Phones

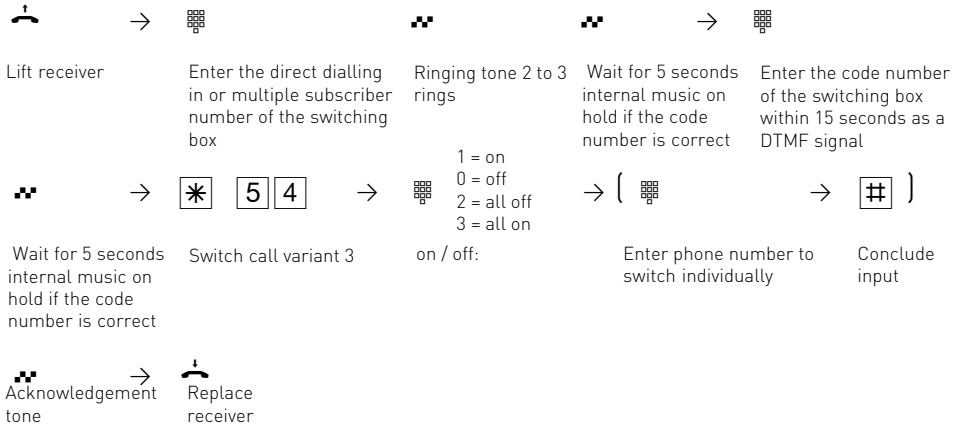

Operation

Call Deflection - Forwarding a call during the ringing phase

Providing this feature is available from your network provider you can forward an incoming call to another extension or outside number whilst ringing. This is useful if you do not wish to answer a particular call.

Call Deflection

ST 40

«(»»



An incoming call arrives and the number is displayed on your phone.

Press the "CALL DEFLECTION BUTTON" You can forward the call to an extension or an outside number.



Dial the number you wish to forward the call to. Press **[*]** to enter an extension number.



Conclude input, the call is now forwarded.

Reject a call during the ringing phase

ST 40



Once your phone rings, press the REJECT Button. Your phone stops ringing, if you are the only phone programmed to ring then the caller will get busy tone returned. If other phones are programmed to ring then the caller continues to hear ringing tone.

Call Forwarding for an extension on a system connection (PTP)

With this feature incoming calls of an extension are diverted during the ringing phase. (Partial Rerouting). Providing that this feature is available from the network provider and that the checkbox is ticked in the program section SO Bus settings. Calls are diverted via the public exchange without engaging the second B Channel.

Operation

Auto Dialling (Hotline)

With this feature a pre-set number is dialled within 10 seconds after lifting the receiver. Calls can still be made normally providing dialling commences within 10 seconds.

Storing a Number for Auto Dialling

ST 40



Start programming



Enter external number or and extension number



Save changes



Enter name



Save changes



Exit programming

Storing an External Number for Auto Dialling

Analogue and ISDN Phones

You must start programming mode by entering: → * 7 0 5



Lift receiver

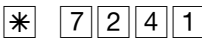

Program the autodial number



Enter an external phone number, max 24 digits



Conclude input, Acknowledgement tone



Replace receiver

Continue programming or end the programming mode by entering: → * 7 0 0

Storing an Extension Number for Auto Dialling

Analogue and ISDN Phones

You must start programming mode by entering: → * 7 0 5



Lift receiver

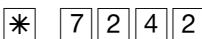

Program the autodial number



Enter an Extension number



Acknowledgement tone



Replace receiver

Continue programming or end the programming mode by entering: → * 7 0 0

Deleting the Number for Auto Dialling

Analogue and ISDN Phones

You must start programming mode by entering: → * 7 0 5



Lift receiver

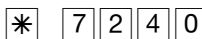

Clear autodial phone number



Acknowledgement tone



Replace receiver

Continue programming or end the programming mode by entering: → * 7 0 0

Operation

Notes

ST 40

Please check your setting after having programmed this feature. Lift the receiver and wait till the programmed number is dialled. Check that you are connected to the correct number.

Switch Auto Dialling on/ off

ST 40



Toggle on or off

End programming

Switch Auto Dialling on/ off

Analogue and ISDN Phones



1 = on
0 = off



Lift receiver

Automatic dialling

on / off:

Acknowledgement
tone

Replace receiver

Notes

If the called party is busy, the telephone system attempts to redial the external phone number every 10 seconds. It cancels automatic dialling after 12 attempts. The Auto Dial function has preference above all other connections. This means should all lines be busy then the Auto Dial feature will force release a line in order to establish a connection. If you hear the error tone when activating AUTO DIALLING, then no external phone number has been programmed.

Operation

Busy on Busy

ST 40

This feature is used in the following situation. If an incoming line is programmed to ring several phones, then each time a new call arrives the free extensions within the group will ring. If, however, for some reason you are the only one in the office and are already on a call then the next incoming call would cause the free extensions to ring. It may not be possible to answer the new call in time and therefore the caller may get the impression that no one is in the office. If Busy on Busy is set on the other hand than any extension within the ringing group who is on a call will cause for a new caller to hear busy tone. Note: This will not place restrictions on outgoing calls.

Programming Busy on Busy

ST 40



Press Set and Busy on Busy Button



Press Arrow Buttons to select the line or name to which Busy on Busy should apply.



Save changes



Exit programming

Switching Busy on Busy on/off

ST 40



The receiver is on hook. By pressing the BUSY ON BUSY Button you switch this feature on or off.

Switching Busy on Busy on/off

Analogue and ISDN Phones



1 = on
0 = off



Lift receiver

Switch busy on busy

on / off:

Enter the external-
phone number

Conclude input,
Acknowledgement
tone

Replace
receiver

Notes

An ISDN terminal that is connected in parallel to the telephone system on a point-to-multipoint line and to which the same number as the system has been assigned will always ring, regardless if BUSY ON BUSY is active or not.

Operation

Voice Message Announcement

ST 40

You can use your telephone system like an intercom, i.e. you can make a voice message announcement to other system telephones connected to the system in the form of a:

- Announcement to one, a group or all system telephones
 - Announcement to a defined group of system telephones (see "Group formation").
- The speakers of the system telephones receiving the announcement are automatically switched on, unless they are busy on another call.

You can also make a voice message announcement out of an external call.

A voice message is only possible if you have programmed a function button as VOICE MESSAGE (Announcement) see also function button assignment.

Voice Message to System Phones

ST 40



Press the ANNOUNCEMENT BUTTON



You now can select an extension number or a group number. If no number is selected all system phones will receive your announcement.



or



Lift Receiver or press Speaker Button.

Voice Message to a System Phone

Analogue and ISDN Phones



Lift receiver

Enter the announcement code

Enter the internal phone number of a system phone or group

Acknowledgement tone

Make the announcement

Voice Message to all system Phones

Analogue and ISDN Phones



Lift receiver

Enter the announcement code

Announcement to all system telephones

Acknowledgement tone

Make the announcement

Voice Message out of an External Call

Analogue and ISDN Phones



You are conducting an external call

Inquiry

Enter the announcement code

Enter the internal phone number of a system -telephone or 0 for all system telephones

Acknowledgement tone

Make the announcement

You can connect back to the external -subscriber after entering **R0** if the -announcement party does not answer or is busy.

Operation

Paging all System Phones from an External Call

Analogue and ISDN Phones

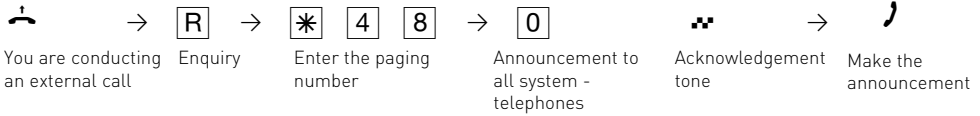

You can connect back to the external -subscriber after entering **R|0** if the -announcement party does not answer or is busy.

On hearing the announcement

ST 40

Press the **SPEAKER** Button or lift the receiver. You will be automatically connected to the announcing extension.

If you are the only extension to which this announcement is directed and providing your phone is programmed for automatic microphone activation, then you can speak to the announcing extension without the need to pick up the receiver or pressing the speaker button.

To end the call press the speaker button or replace the receiver.

Notes

Paging is only possible to system telephone and at least one must not be busy on a call.

If an extension is set so that the microphone will be automatically activated on an announcement to a single extension, then that extension does not need to lift the receiver or press the handsfree button to speak to the paging extension. (see also system phone settings) The connection will be automatically be activated in handsfree mode.

The volume of the announcement can be adjusted by using the "Volume Control". With the "set" and paging button you will be able to program a set of extensions to make an announcement to a group.

To return to the trunk call in progress, press the button "Disconnect". 

Operation

To place a Call on Hold

You can put a call on hold in order to make an enquiry call via the ISDN exchange, however this is only possible if your line is a Point-To-Multipoint connection. Note: This feature may not be available from your network provider. (not available from network providers in the UK) This feature would allow to make an enquiry call to another outside number even though no line (B Channel) is available. The call is put on hold in the exchange therefore releasing a line to be used to set up another call. You then can alternate between the calls by using the SPLIT button.

Place a Call on Hold

ST 40



You are on an outside call (Point-to-Multipoint only)

Press the ISDN HOLD Button, you hear external dial tone

Dial the required telephone number
The display on your phone will show the current call connected to

If the other party does not answer and you want to return to your original call press "back"

Press the ISDN HOLD Button to switch between calls.



On pressing "release" you will clear the current call and be returned to the other call.

Place a Call on Hold

Analogue and ISDN Phones

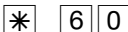

Conduct external call

enquiry

First external call on hold



External dial tone

Enter external phone number

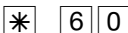

Conduct enquiry:

enquiry

Return to first - external call



Continue first - external call

Notes

A call cannot be placed on hold in the exchange if you hear the error tone. You are connected back to the other call by entering **R|0**.

When you replace your receiver, you will clear both calls, the current and the holding one. Call charges are incurred for the current call and for the one on hold.

Operation

Remote Dial Functions

With this feature it is possible to dial a number on behalf of another extension. (i. e. the Secretary for the Manager) This feature must be enabled on the extension for which calls can be made. At the time system phones only can set up calls for other extensions. The following options are available:

- Remote Dial all (every extension can set up a call for you)
- Remote Dial off
- Remote Dial allowed from extension/group
- Remote Dial allowed via CTI
- Remote Dial switches system telephone to handsfree and dials number (system phones only).

Remote Dialling

ST 40



With the handset on hook. Select the Remote Dial Menu, press middle button and enter your PIN if prompted.



Select the remote dial required (off, Extn number, all external) with arrow buttons and activate selection with middle button



If Extension Number was selected, enter desired extension number and confirm with middle button

CTI-Dialling

ST 40



With the handset on hook. Select the Remote Dial Menu



Select CTI-Dialling with arrow buttons and activate with middle button.

Automatic Call and Automatic Mike

Please proceed exactly as for CTI dialling for the items Automatic Call & Automatic Mike.

Operation

Enable Remote Dialling Funktion

Analogue and ISDN Phones

The following options are available for analogue phones.

-Remote Dialling off/on (allow for all)

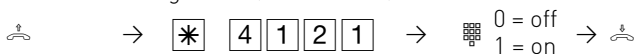

- Remote Dialling allowed from extension

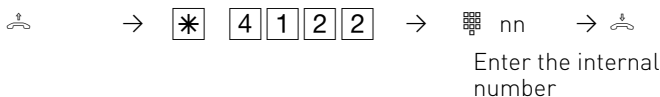

- Remote Dialling allowed via CTI per port

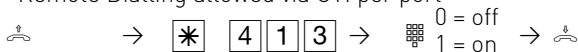

- Remote Dialling going off hook automatically

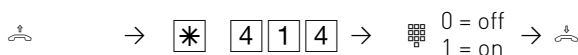

To Dial for another Telephone

ST 40



The receiver is on hook.
Press the button
"Remote Dial"

If no extension is preprogrammed on the
button "Remote Dial" then you must enter
the extension for which you want to dial and
confirm this by pressing the middle button.

Enter the number to be called, if an
extension is to be called, then please
prefix the number with # and
confirm this by pressing the middle
button.

Malicious Call Identification (MCID)

This feature will have to be supplied by your network provider.

The ISDN exchange will store the callers number and the date and time of the call.

This trace can be activated during the call or after the caller has hung up but must be activated before you terminate the call.

Tracing a Call

ST 40



On receiving a Nuisance or
Malicious call and want the
ISDN exchange to trace it



Press the CALL TRACING
Button You will hear an
acknowledgement tone
from the exchange.



Replace the
receiver

Operation

Tracing a Call

Analogue and ISDN Phones

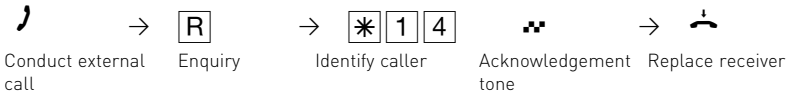

Notes

You can continue the call after **R*14**.

Until you return to the caller he will hear Music on Hold if applicable.

You hear the error tone if:

- Malicious Call Identification has not been made available by your network operator
- OR
- when the caller could not be identified by the telephone exchange.

Press "stop" if you want to continue the call after the trace has been activated.

Until you return to the caller he will hear Music on Hold if applicable.

You hear the error tone if:

- Malicious Call Identification has not been made available by your network operator
- OR
- when the caller could not be identified by the telephone exchange.

Operation

Conference

Three Party Conference via your Phone System

You can hold a three party conference with analogue or digital extensions of the system.
Or with one external call and one extension
Or with two external calls. Note you will use 2 lines (B Channels)

Three Party Conference via the ISDN Telephone Exchange (PTMP lines only)

Note this service is a feature of the Telephone Exchange and may not be available.
To establish a three party conference via the exchange you must first establish the call with the first party. Then hold the call in the exchange to establish an enquiry call on the same line to the second party after which you will switch to a three party conference.

Three Party Conference (with two other extensions)

ST 40



You are on an internal call



Press the INTERNAL Button and dial the second extension number



Press Softkey "conference". All extensions will hear the confirmation tone.



The conference call is established.

Three Party Conference (with two other extensions)

Analogue and ISDN Phones



You are conducting an internal call

Enquiry, enter internal phone number

Conduct inquiry call

Enquiry, enter conference code

Acknowledgement tone, Conference with three parties

Internal - External Three Party conference

ST 40



Whilst on an external call



Press the SPLIT Button and dial the required telephone number



The called party has answered



Press softkey "conference". You hear the acknowledgement tone.



The three party conference call is established.

Internal - External Three Party conference

Analogue and ISDN Phones



You are conducting an internal or - external call

Enquiry, enter "R" and external or internal phone number

Conduct inquiry call

Enquiry, enter conference code

Acknowledgement tone, Conference with two internal users and one external subscriber

Operation

ISDN Three Party Conference

ST 40



Whilst on a call press the ISDN Hold button



You hear external dial tone.
Dial the new number required. Your first caller is put on hold and cannot overhear the conversation.



If the new call is answered you can announce the conference. If the new called number fails to answer, then press ESC you will now be connected to the original call. Your Three Party Conference will be cleared once you replace your receiver.



Press the CONFERENCE button your Three Party Conference has been established.



Replace receiver to end the conference

ISDN Three Party Conference

Analogue and ISDN Phones



R



*

6

0



Conduct external call Enquiry

First external call on hold in the exchange

External dial tone Enter external phone number



R



*

6

1



Conduct inquiry Enquiry

Code for ISDN three-party conference

Acknowledgement tone Three-party conference with two external subscribers

Notes

Three Party Conference via the Telephone System.

An incoming – or doorphone call will be signalled to the conference with the call waiting tone if the called extension is part of the conference.

The Pick Up of a call is only possible by the extension who established the conference (Conference Manager) by pressing the SPLIT button and selecting the call with the next button. The other members of the conference are put on hold until the conference manager has finished the enquiry call by pressing the ESC button after which he can re-establish the conference with the SPLIT and the CONFERENCE button. If an extension replaces the receiver then that extension is disconnected from the conference and can only be re invited via the conference manager. The conference is cancelled as soon as the conference manager replaces his receiver.

Conference circuit via the ISDN exchange

Call charges are incurred for every participant of the conference. If you hear an error tone instead of an exchange dial tone, then the holding of a call in the exchange is not possible. Press the ESC button to return to the original call. The Three Party Conference is not possible if you hear the error tone after pressing the CONFERENCE button. Press the ESC button to reconnect to the original call. Press the CONFERENCE button if you wish to clear an established ISDN Three Party Conference. You are connected to the party that you last invited into the conference. The first called party is put on hold.

Operation

Notes on Analogue and ISDN-Phones

Three Party Conference via the Telephone System.

An incoming – or doorphone call will be signalled to the conference with the call waiting tone if the called extension is part of the conference.

The Pick Up of a call is only possible by the extension who established the conference (Conference Manager) by pressing **[R][*][8]**. The conference manager can pick up a door call by entering **[R][*][1][1]**. The other members of the conference are put on hold until the conference manager has finished the enquiry call by pressing **[R][R]** after the conference is re established. If an extension replaces the receiver then that extension is disconnected from the conference and can only be re invited via the conference manager. The conference is cancelled as soon as the conference manager replaces the receiver.

Conference circuit via the ISDN exchange

Call charges are incurred for every participant of the conference. If you hear an error tone instead of an exchange dial tone, then the holding of a call in the exchange is not possible. Press **[R][0]** to return to the original call. You end the conference by replacing the receiver. You are connected to the party that you last invited into the conference. The first called party is put on hold.

Least Cost Routing (LCR)

This feature will make use of various network providers offering cheap call rates. Calls are routed depending on the STD Code dialled which is also dependent on the time and day of the

week. If it is not possible to connect to the relevant provider after a preset number of attempts then the system will try to route the call via a preset alternative provider. (Fallback)

The access code of the relevant provider will be prefixed by the system to the number dialled.

The Least Cost Routing can cater for up to 8 network providers in 8 time slots depending on time of day and day of week. Least Cost Routing can be programmed with TK-Suite on your PC. Least Cost Routing can be switched on or off on your extension.

Switching Least Cost Routing (LCR) on/off

ST 40



Press the LCR function button to switch this feature on or off for your extension.

Operation

Switching Least Cost Routing (LCR) on/off

Analogue and ISDN Phones



1 = on
0 = off



Lift receiver

Code for LCR

on / off:

Acknowledgement tone

Replace receiver

Notes

You can still select which network provider is used for your call despite LCR being enabled.

- Simply prefix your number with the network access code
- You can also select the network provider with the function button CALL BY CALL on a system phone. (see also Network access code -Call by Call).

The network access code for the network operator is only stored in the last number redial memory if this has been dialled manually before.

Important! Not all ISDN features described may be available. Please check with your network provider for availability.

Carrier Access Code – on a Call by Call basis

You can select an alternative network provider on a Call by Call basis with an assigned function button. Press the function button to select a provider and dial the required telephone number. You can call numbers from your own memory, central dialling (Phone Book) or last number redial. To use this feature you must have a network provider stored in the feature button called CALL BY CALL. You can select a network provider from the LCR table to assign this to the CALL BY CALL button.

Storing the network provider for the 'Call by Call' Button

ST 40



Start programming by pressing SET followed by the CALL BY CALL function button.



A already stored provider will be displayed press arrow buttons to select another provider.



Confirm selection



Exit Programming

Operation

Dialling with Call by Call Button

ST 40



Lift the receiver and press the "Call by Call" button. The stored network access code is displayed and dialled.



Dial the required telephone number (STD + Number) or select the number by pressing a Speed Dial Button or Last Number Redial.

Notes

The network access code which has been dialled with the Call By Call button will not be stored in the last number redial.

Call Split (Brokers Call) switching between calls

Brokers Call is a feature whereby you can talk to one internal and one external call in turn without connecting them. Call Split is the same feature but it is possible to do this between external calls. The waiting caller will hear Music on Hold if applicable.

Call Split

ST 40



The active call is displayed in the first line and the waiting or call on hold is displayed in the second line of the LCD. Should another call arrive then again as before the new callers details are displayed in the first line of the LCD. By pressing the SPLIT button you are connected to the new caller. Pressing the SPLIT button in succession will connect you to each waiting caller in turn.

1st line LCD Number / Name or External
2nd line LCD Number / or Name of line



To switch to call displayed
Press SPLIT

Notes

Some function buttons of the system phones may refer to the above described feature as Brokers Call.

Call charges will be incurred for all outgoing calls even whilst on hold. To end a current call, press the "esc" key. You are automatically connected to the next call waiting.

If you replace the receiver:

- you clear all extension calls,
- you clear the current external call,
- you receive a callback if an external call is still on hold.



Operation

Call Log

All calls will be displayed which are still stored in the systems memory. This list can be displayed by pressing the redial button for more than 2 seconds. In addition the number displayed may be stored in the phone book by pressing the phone book button.

Store a Number in the Phone Book

ST 40

  2 Seconds

Display the Call Log



using the arrow buttons select the entry which you would like to store



Press the Phone Book Button





Enter the required name



Confirm the entry by pressing the middle button.

Store a Number on a Single Button

ST 40

  2 Seconds

Display the Call Log



using the arrow buttons select the entry which you would like to store



Press the Button for the number to be stored





Enter the required name



Confirm the entry by pressing the middle button.

Call a Number

ST 40

  2 Seconds

Display the Call Log



using the arrow buttons select the number you wish to call



lift the receiver

Operation

Parking a Call

You can park an external call in the system and retrieve this from another extension. The parked call will engage the line (B Channel). The parked caller will hear Music on hold (if enabled). Calls parked will recall your extension within 4 minutes if it has not been retrieved.

Calls can also be parked or retrieved with an index number. This feature is useful if several calls are parked at any time.

This function can be activated in the configuration section 'other functions' or via a program entry on the phone.

Parking / Retrieving a Call

ST 40

Parking a Call:

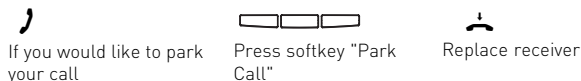

Retrieving a Call:

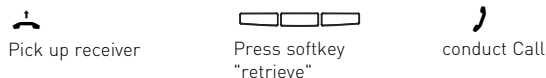

Parking / Retrieving a Call

Analogue and ISDN Phones

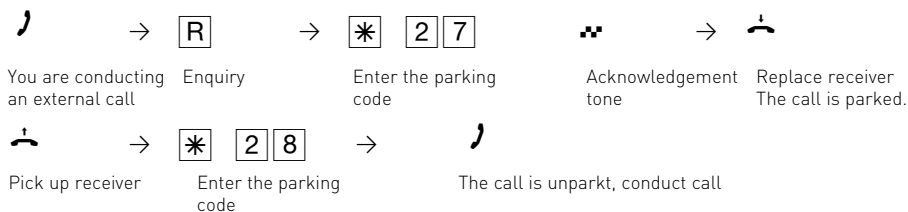

Operation

Activating/deactivating Parking with Index Number

Analogue and ISDN Phones

Activating parking with index number

* 7 3 5 1

Deactivating parking with index number

* 7 3 5 0

Parking/ Retrieving a Call with Index Number

ST 40

Parking the Call:



If you would like to park your call

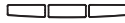

Press softkey "Park Call"



Enter a 2 digit index number from 00 to 99.



Replace receiver

Retrieving a Call:



Lift receiver



Press softkey "retrieve"



Enter a 2 digit index number from 00 to 99.



The Call is reconnected

Parking/ / Retrieving a Call with Index Number

Analogue and ISDN Phones

Park call and assign two-digit index (00-99)

* 2 7

Unpark call and enter two-digit index (00-99).

* 2 8

Notes

You can retrieve a parked call from any telephone.

On the standard phone dial * 2 2 to retrieve a parked call. If several calls are parked then the first one will be returned. Outgoing call incur charges when parked.

Operation

Baby Listening / Room Monitor

Any phone can be used for this feature (system- or standard phone) The phone set to Room Monitor (Baby Listening) can be called from any telephone either internal or external. A system phone when called will switch on the microphone automatically. This feature must be enabled for the phone intended to be used as a monitor. You can select whether or not a warning tone sounds when listening into a room. The monitor phone can be called from any phone either internal or external. Please refer to the instruction manual chapter 'Room monitoring from an analogue phone' on how to access this feature from an external phone.

Set Up Room Monitor

ST 40



Set Up Room Monitor



Switch on or off



Select audible warning setting



Switch on or off



exit programming

Set Up Room Monitor

Analogue Phones



Lift receiver in the room to monitor

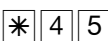

Initiate room - monitoring



Acknowledgement tone



Place receiver next to the guarding telephone

Calling the Room Monitor Extension

ST 40



Lift receiver



Enter the guarding telephone's internal phone number



Listen into the room. Please note that you can also be heard when listening into a room.

Calling the Room Monitor Extension

Analogue and ISDN Phones



Lift receiver

Enter the guarding telephone's internal phone number



Listen into the room. Please note that you can also be heard when listening into a room.

Operation

Calling the Room Monitor Extension from external

Analogue and ISDN Phones



Lift receiver



Enter the direct dialling in or multiple subscriber number of the switching box



Ringing tone 2 to 3 rings



Wait for 5 seconds internal music on hold



Enter the code number for the switching box within 15 seconds as a DTMF signal



Wait for s5 seconds internal music on hold if the code number is correct



Enter the internal number of the guarding telephone



Listen into the room

Cancelling room monitoring

Analogue and ISDN Phones



Replace receiver in the monitored room

Notes

You can also use a telephone in the hands free mode as the guarding telephone. You cannot use an ISDN telephone on the internal S0 bus as a guarding telephone. The internal phone number of the switching box must be entered as the only internal phone number in the call variants (ringing distribution settings) of one multiple subscriber number.

If you hear the busy tone after dialling up the guarding telephone, the room is already being monitored by another caller. Within 15 seconds you must enter the right code number as a DTMF signal with a DTMF hand-held transmitter or telephone as otherwise the telephone system will clear the connection.

Please note, you can also be heard at the monitored phone.

Operation

Enquiry

You can place your current call on hold, while you talk to an extension or another external call. The caller on hold will hear Music on Hold and can not overhear your conversation. Whilst on an enquiry call you can use all functions such as telephone book, paging etc.

Telephone Enquiry

ST 40



Whilst having a telephone conversation

Internal Enquiry

Press Button Enquiry and dial extension number .

or External Enquiry

Press the Split or Brokers Call button an dial external telephone number



or



Whilst talking to the new call the call on hold cannot hear your conversation.

To return to the waiting call:
Press Softkey "release" to release enquiry call
or
Press the Split or Brokers Call Button, the enquiry call is put on hold.

Internal Enquiry

Analogue and ISDN Phones



Conduct first call

enquiry First call is on hold

Enter internal phone number

Conduct inquiry call

Enquiry call and first call are placed on hold



Enter ".0" to switch to the external call or the internal number to switch to the internal call



etc.

Back to the first call:

Continue first call

External Enquiry

Analogue and ISDN Phones



Conduct first call

enquiry First call is on hold

Enter external phone number

Conduct enquiry call

Enquiry call and first call are on hold



Enter ".0" to switch to the external call or the internal phone number to switch to the internal call



etc.

Back to first call:

Continue first call

Operation

Enquiry (Mute)

ST 40

To talk to another person in the room without the caller being able to hear:



internal or external call

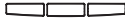

Press Softkey "Enquiry", The Call is put on hold. You now can talk to someone in the room without the caller hearing this.



Press "Back" to return to the call put on hold

Enquiry (Mute)

Analogue and ISDN Phones



Internal or external call

Connection is placed on hold. You can talk without the telephone partner hearing.

Continue telephone call

Replace the receiver

Operation

Automatic Call Back

You can set up an automatic call back if the number you are calling is busy. This feature is only available to subscribers of ISDN lines. Your phone will ring as soon as the called party replaces the receiver. The other party will be called automatically as soon as you pick up your receiver.

Set Up Call Back

ST 40



On hearing the busy tone

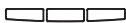

Press Softkey "recall",
Call Back is initiated



Replace receiver

Set Up Call Back

Analogue and ISDN Phones



Lift receiver



Call the external
subscriber, busy tone, the
subscriber is busy



Set Up Callback



Acknowledgement
tone of the
exchange



Replace
receiver

Receiving a Call Back

Your telephone rings as soon as the other party is free again. The display shows the callback. Lift the receiver. The other party is automatically called back. Should the called number fail to answer then you details will be entered in the Call Log.

Notes

If your display reads:

```
Number busy  
replace receiver
```

then it will not be possible to be called back from the busy number. The feature Call Back on busy is not available from the telephone exchange. The feature will be cancelled.

if you do not answer the returned call within 20 seconds.

Call Back will be cancelled if the Call Back feature is completed or failed to connect the call after 45 minutes.

Operation

View Extension Status

It may also be possible that several functions are active, this will be indicated by the corresponding symbols. You can view the status and or messages in order of succession.

Scrolling through Display Messages

ST 40



The receiver is on hook. You will see the a symbol (e.g. "☎") to indicate an entry. The date will be displayed.



Browse by pressing the arrow buttons. Phone settings such as "Diversion" may be indicated.



Press Middle Butto to read



Display will return to default after 20 seconds. Press right button to return to default immediately.

Notes

Should you receive a call during the display of features, then the callers number will be displayed and your phone can be operated as usual.

Set Extension Names

ST 40

You can set a name for your telephone extension. Your name will then appears in the display of other system phones you are calling.



Enter programming mode



Enter name with the dial keypad



confirm entry



end programming

Operation

Enter Names with number buttons

ST 40

Press 1..0 several times if necessary,

For Example: 2 = A

22 = B

222 = C

2222 = 2

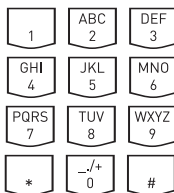

Press (▶) to enter the next field or wait for the cursor to move over automatically.

Press (◀) to enter the previous field.

Flashing character can be deleted by pressing the left button

Delete complete entry by holding the left button pressed for at least 1 sec.

Change between upper or lower case by holding number button pressed.

Operation

Storing Phonebook Numbers (Central Dialling Memory)

Up to 1000 telephone numbers and names can be stored in the central dialling memory. The numbers can be recalled by pressing the Phonebook button available on every system phone. You can also store program functions and use the and (R)ecall buttons.

With this method all features could be used from telephones who do not support or have the and R button. Single button memory (Emergency) dialling is reserved for the and buttons. You can centrally store up 1000 important external phone numbers and affiliated names in the telephone system. These telephone numbers can then be selected from every system telephone by pressing the "phonebook" button, either via a numeric or an alphabetical register.

Storing a number

ST 40

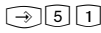

Start Programming



Enter the number you wish to store



confirm



Enter the name



confirm



end programming

Phonebook - storing a number

Analogue and ISDN Phones

You must start programming mode by entering: →

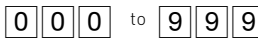
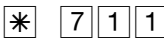

Lift receiver

Enter the phonebook programming code

Enter the location of the number to store



Enter an external phone number without „9“ (outside line seizure)

Confirm input



Acknowledgement tone

Replace receiver

Continue programming or end the programming mode by entering: →

Notes

When storing a number do not use the line access digit. The outside line is automatically seized when a number is dialled from the Phonebook. Dialled numbers from the Phonebook can be added too from your phone if additional digits will be dialled within 20 seconds. Users may dial from the Phonebook regardless if they are call barred or not. Stored emergency and Babysitter numbers can always be dialled even if the preset cost limit has been reached.

Operation

Changing a Number in the Phonebook

ST 40

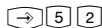

Start Programming



Press "Search", choose between retrieval methods and confirm with middle button.



Choose stored number, you wish to change and confirm with middle button

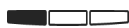

Clear digits of phone number with left button





Change phonenumber and confirm with middle button

Confirm or clear and modify the displayed name



End programming

Notes

If "no entry" is displayed after a number has been entered, then by pressing  will go backwards from 999 and  will go forward from 000.

Deleting a Number from the phonebook

ST 40

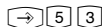

Start Programming



Choose stored number, you wish to delete and confirm with middle button



confirm delete with middle button



End programming

Deleting a Number from the phonebook

Analogue and ISDN Phones

You must start programming mode by entering:  → *705  

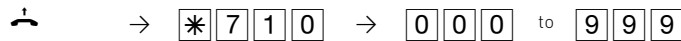

Lift receiver



Enter the code for clearing and entry

Enter the location of the number to clear



Acknowledgement tone

Replace receiver

Continue programming or end the programming mode by entering:  → *700  

Operation

Emergency and Direct Dial Numbers

ST 40

You are able to enter emergency and direct dial numbers in the system. These may be used after the phone lock has been activated.

Entering Emergency Numbers

ST 40

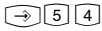

5 4

Start programming



choose emergency button



Enter emergency number and confirm with middle button





Enter name and confirm with middle button



End programming

Entering Emergency Number *

Analogue and ISDN Phones

You must start programming mode by entering:  →  7 0 5  



 7 2 9 1 1









Lift receiver

Enter Emergency Number 

Emergency Number

Conclude programming, acknowledgement tone

Replace receiver

Continue programming or end the programming mode by entering:  →  7 0 0  

Entering Emergency Number

Analogue and ISDN Phones

You must start programming mode by entering:  →  7 0 5  



 7 2 9 2 1









Lift receiver

Enter Emergency Number 

Emergency Number

Conclude programming, acknowledgement tone

Replace receiver

Continue programming or end the programming mode by entering:  →  7 0 0  

Delete Emergency Number *

Analogue and ISDN Phones

You must start programming mode by entering:  →  7 0 5  



 7 2 9 1 0









Lift receiver

Delete Emergency Number 

acknowledgement tone







Replace receiver









Continue programming or end the programming mode by entering:  →  7 0 0  

Operation

Delete Emergency Number

Analogue and ISDN Phones

You must start programming mode by entering:  →      







 →       →  → 

Lift receiver

Delete Emergency
Number 

acknowledgement
tone





Replace receiver









Continue programming or end the programming mode by entering:  →      



Enter Line for Emergency Calls

Analogue and ISDN Phones

You may enter the line, which is used when dialling an emergency number:

You must start programming mode by entering:  →      

       → 

 enter  

 delete







Lift
receiver

Enter Line for
Emergency Calls

On choosing  enter the
external line the shall be
used by emergency calls.

acknowledgement
tone

Replace
receiver

Continue programming or end the programming mode by entering:  →      

Operation

Store a Direct Call Number

ST 40

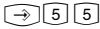

Start programming



Enter direct Call number and confirm with middle button



Enter Name and confirm with middle button



exit programming

Store a Direct Call Number

Analogue and ISDN Phones

You must start programming mode by entering: →

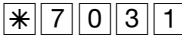

Lift receiver

Store Direct Call number

Enter Direct Call Number without „9”

Conclude programming, acknowledgement tone

Replace receiver

Continue programming or end the programming mode by entering: →

Store a Direct Call Number

Analogue and ISDN Phones

You must start programming mode by entering: →



Lift receiver

Clear Direct Call Number

acknowledgement tone

Replace receiver

Continue programming or end the programming mode by entering: →

Operation

Dialling Numbers from the Phone Book

Numbers in the Phone Book can be retrieved alphabetical, numerical or as vanity dial. Vanity dialling: With the Vanity dialling you do not have to remember the location of the speed dial number in the phone book. Just enter the name. The name will be displayed as soon as a match has been found.

Example:

Dellmann

Diener

Edner

Fenlo

Select entries in the phone book with:

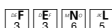
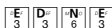

Changing the retrieval method

ST 40



Press
Phonebook
button



Press "Search", choose search mode with
arrow buttons and confirm with middle button



Phonebook (Numeric retrieval)

ST 40



Press
Phonebook
button



Enter the stored
location of the entry, ie 000 to 999 or use
arrow buttons to scroll.



or



Lift the receiver or press the handsfree
button. The displayed number will be
dialled.

Phonebook (Numeric retrieval)

Analogue and ISDN Phones



Lift receiver



Enter the
phonebook code



Enter the phonebook destination 0 0 0 to 9 9 9 ;
the stored phone number is dialled.



Conduct
the call

Operation

Phonebook (Vanity retrieval)

ST 40



Press Phonebook button

Enter the desired letter, ie. A = 2. The first entry with the selected initial letter is displayed.



Select the next letter, ie. N = 6. The first entry with "An " is displayed.



or



Lift the receiver or press the handsfree button, the displayed name will automatically be dialled.

Scroll with arrow buttons  

Phonebook (Vanity retrieval)

Analogue and ISDN Phones



Lift the receiver

Start Vanity dialling

Enter name



External dialling tone if name has been clearly identified. The destination is dialled automatically after 4 seconds or immediately after entering an .



Ringing tone, subscriber is called



Hold conversation

Phonebook (Alphabetic retrieval)

ST 40



Press Phonebook button

Enter the desired letter, ie. A = 2. The first entry with the selected initial letter is displayed.

Press the arrow button to move to the input for the second letter.



Enter the second letter, i. e. N = 66.



or



Lift the receiver or press the handsfree button. The displayed phone number will be dialled automatically.

Scroll with arrow buttons  

Operation

Redial a Number from the Phonebook

ST 40



Press the Phonebook button



You are in the last used method of retrieval (numeric or alphabetical). Press the REDIAL button. The entry that was last displayed or dialled will be shown.



or



Lift the receiver or press the handsfree button you will be connected to the displayed number.

Notes

You can set in the configuration of the system, if extensions which have no line access can dial numbers from the phonebook.

If your extension is barred, then you cannot dial numbers from the phonebook which fall into this category. You will hear error tone.

The phonebook will always be displayed in the last used method of retrieval (numeric or alphanumeric).

If a number has been stored without a name in the phone book, then the only method of retrieval will be numeric.

Abbreviated numbers can also be dialled if the telephone receiver is off hook, for example when on an enquiry call. In this case you have to select the required number by pressing the button ENTER.

Incomplete telephone numbers can be added too: Select abbreviated number, pick up handset or press handsfree button, then add required digits to telephone number.

Operation

Telephone Lock - Emergency/ Direct Call (Baby Call)

You can protect your telephone against unauthorised use by locking it.

If your telephone is locked,you can:

- only call extensions
- accept all incoming calls and transfer them to extensions
- only call the stored emergency and direct call phone number.

In addition you can use automatic dialling (Hotline) but this feature must have been enabled before locking your phone. If you have programmed a PIN number for your phone, then this must be entered to either lock or unlock your phone.

Locking your Phone (with Function Button)

ST 40



With the receiver on hook.Press the "Telephone lock "button.(if programmed) The telephone is locked. If a PIN number is prompted then this must be entered before the phone can be locked. Error tone will be returned in an attempt to dial a number whilst the phone is locked.

Locking your Phone

Analogue and ISDN Phones

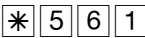

Lift receiver

Lock the phone

Acknowledgement tone

Replace receiver

Unlocking your Phone (with Function Button)

ST 40



With the receiver on hook.Press the "Telephone lock "button.The telephone is unlocked. If a PIN number is prompted then this must be entered first before the phone can be unlocked.

Unlocking your Phone

Analogue and ISDN Phones

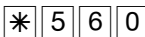

Lift receiver

Unlock phone

Acknowledgement tone, enter the telephone code if nessecary

Replace receiver

Operation

Locking your Phone (without Function Button)

ST 40



Press SET 13.
Enter the PIN number if prompted. The current setting is displayed.

Press middle Button. Your telephone is locked

The display shows "Telephone lock" or, Emergency/ Baby call if this has been stored. Error tone will be returned for anyone trying to make an outside call.

Unlocking your Phone (without Function Button)

ST 40



Press Set

Press middle Button.
Enter the PIN number if prompted. Your telephone is unlocked

Emergency Call

ST 40



The telephone is locked and the receiver is on hook.



Emergency call * or # only. The phone number is displayed.



Lift the receiver. The phone number is dialled automatically or press the handsfree button to dial the displayed number.

Emergency Call

Analogue and ISDN Phones

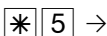

Hörer abnehmen

Notruf



Notrufnummer 1 wählen



Notrufnummer 2 wählen

Gespräch führen

Direct Call (Baby Call)

ST 40



The telephone is locked. Receiver is on hook.



When any button but "*" or "#" is pressed, the phone number stored as the direct number is shown in the display.



Lift the receiver to start dialling

Direct Call (Baby Call)

Analogue and ISDN Phones

The Telephone is locked. When any button but * or # is pressed, the number stored as the direct number is dialled.

Operation

Notes

ST 40

The emergency call/direct call function has priority over all outside connections in progress. If necessary a call in progress will be force released in order that the emergency call can be set up.

Pogramming Telephone Lock (PIN)

ST 40



To program PIN Number
Press SET27
Enter old PIN if prompted.



Enter new 4 digit PIN
number



Save PIN



Exit programming

Pogramming Telephone Lock (PIN)

Analogue and ISDN Phones



Lift receiver

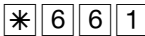

Program PIN



Enter old PIN



Enter the new 4-digit PIN
(0000 to 9999),
acknowledgement tone



Replace
receiver

Clearing Telephone Lock (PIN)

Analogue and ISDN Phones



Lift receiver

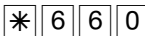

Clear PIN



Enter PIN



Acknowledgement
tone



Replace receiver

Operation

Appointment Call (Non-Recurring)

Your telephone can remind you of an appointment. At a set date and time your phone will ring to remind you. This function can be switched on or off at any time. An appointment call will ring even if your phone has been set to DO NOT DISTURB.

Set Up an Appointment Call

ST 40



Press Set and appointment button



Enter the time in the 24 hour format HHMM and press the middle button



Today's Date is shown. Enter new date if required and press middle button to save.

If an appointment is stored, its activated automatically. The clock symbol is shown on the ST 40 display.

Switch Appointment Call on/off

ST 40



Press the appointment button. The stored appointment time appears in the display



Switch on or off

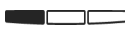

You can postpone the appointment by 15 minutes

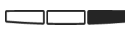

Press right button to go back to standby display

Receiving an Appointment Call

ST 40

The appointment call rings at the set time. Your display shows the "Appointment call" message for 20 seconds. As long as "Appointment call" is displayed, you can switch it off by pressing the middle button.  At any other time you must press the button APPOINTMENT for this feature to be switched off.

Notes

You are only reminded of an appointment if this has been switched on. To stop further appointment calls, switch this feature off. You can switch a stored appointment on or off with the APPOINTMENT button. (Toggle switch)

If you are on the phone while your appointment call tries to ring you then the message, Appointment Call' will be displayed for 20 seconds with the red LED flashing. After you have replaced your receiver the Clock Symbol and red LED will continue to flash to remind you of the expired appointment. Switch off appointment call by pressing the associated button. An appointment call will only ring your phone even if a diversion has been set.

Operation

Timer Control

The telephone system has timers that can be used to activate certain functions at specific times. The following features can be time controlled:

- AIS announcement text
- Busy-on-busy
- Call barring
- Call Distributiou by Day / Night
- Call Distributiou Door
- Call Distributiou Forwarding
- Diversion
- Do not disturb
- Hunt group mode
- Phone lock
- Phonebook Macro
- Relays
- Sensor
- TAM

You can assign one or more functions to any timer. Up to 10 functions can be switched by timers. The timers can only be programmed in the "TK-Suite" program.

Timers can be switched on or off manually from any phone for example the Office closes early and therefore night service needs to be switched on prior to the set time. Several timers can be grouped into one so that they can be activated simultaneously.

Timer Functions Switch on/off

ST 40

Press the button "Multifunction" to activate the preset time in the telephone system. If the Multifunction button has been programmed as timer control, then by pressing this button the function can be switched on or off.

The following options are offered if the multifunction button is programmed as a menu selection:

left button to switch the functions of timer control on or off

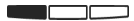

middle button to switch the timer control on or off.



Should you switch the timer control on or off, then you will have enabled or disabled the allocated functions to this. However, you may switch off functions momentarily when activation the timer control. The functions will operate normally as set on the next time circle.

Timer Functions Switch on/off

Analogue and ISDN Phones



Lift receiver

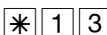

Code for Timer



Timer group



0 = Timer off
1 = Timer on
2 = Function off
3 = Function
and timer on



Acknowledgement
tone



Replace
receiver

Operation

Switching over the door call variant

Which phones are to ring when the bell push is pressed are set with the doorphone setting variant 1 and 2, day- night service call distribution setting. The doorphone class of service can be switched from any telephone, internal or external. If you change this from an external number then you have to dial the switch box which can be accessed via a DDI number on a PTP or a MSN number for a PTMP line.

If Night Service has been switched off, then Day Service is enabled.

Doorphone Night Service on / off

ST 40



Press set and Night Service Button



Choose extension number of door



Switch on or off



Exit programming

Doorphone Night Service on / off

Analogue and ISDN Phones

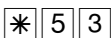

Lift receiver

Doorphone Night Service on/off

Acknowledgement tone

Replace receiver

Doorphone Night Service on / off from external

Analogue and ISDN Phones



Lift receiver

Enter the direct dialling in or multiple subscriber number of the switching box

Ringing tone 2 to 3 rings

Wait for 5 seconds internal music on hold

Enter the code number of the switching box within 15 seconds as a DTMF signal

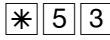

Wait for 5 seconds internal music on hold if the code number is correct

Doorphone Night Service on/off

on / off:

Extension Number of Doorphone

Acknowledgement tone

Replace receiver

Notes

If the selection „ext. all” is set up when Night Service is switched on/off, Night Service is switched on/off at the same time.

Operation

Doorphone Diversion to External Number

You can divert your doorphone to any external number, including mobile, if you want to be contactable by a visitor even though you are not in the building. Regardless of the set diversion the internal extension will still ring and can also be answered by the extension. If you divert to an ISDN terminal capable to display the calling number, then the identification of a doorphone call is possible and you can answer accordingly. You can also enable or disable a programmed doorphone diversion from any external telephone. For instruction on how to do this remotely please refer to the user manual for analogue phones section 'Diverting a doorphone to an external number'.

Programming and Diversion of a Doorphone

ST 40



Press the SET and function button DI-VERSION TO



Enter the doorphone extension number which is going to be diverted



Enter telephone number to which the call will be forwarded or choose number from phone book



Confirm with middle button



"1": permanent (all Calls)



switch on or off



End programming

Diversion To - on

Analogue and ISDN Phones

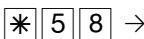

1 = external phone number
3 = phonebook number



Lift receiver

Doorphone Diversion

Diversion destination:

Enter extension number of bell push



Conclude input



Enter the external phone number or phonebook number

Acknowledgement tone

Replace receiver

Diversion To - off

Analogue and ISDN Phones

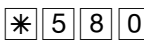

Enter extension number of bell push



Lift receiver

Doorphone Diversion off

Acknowledgement tone

Replace receiver

Operation

Doorphone Diversion on / off from external

Analogue and ISDN Phones

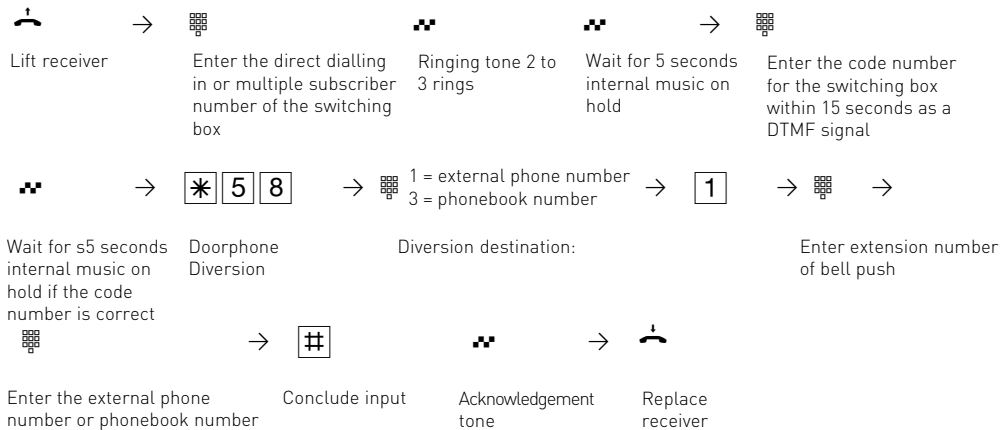

Notes

The external number will ring for 30 seconds, after which the call is cancelled. The external Doorcall will be disconnected after 10 minutes. The door opener cannot be activated from a diverted call.

Operation

Operating the Doorphone and Door opener

You can speak to someone at the door if your system has a doorphone (TFE) connected to it. Your phone will ring with a distinctive ringing sequence if a visitor presses the bell push at the doorphone. The door call can still be answered 30 seconds after the last ringing sequence. (or for as long as the red LED flashes) The doorphone will be answered as soon as you lift the receiver on your phone. You also can activate the door opener from your phone whilst speaking to the doorphone. You can also Call Pick Up a doorphone call that rings at another extension. Your extension will be busy during the connection to the doorphone.

Operating the Doorphone and Door opener

ST 40



The receiver is on the hook. The doorphone rings your extension



Lift the receiver, you are now connected to the doorphone



To release the door press the 'DOOR' button. The door opener is activated for three seconds.

Answering a Doorphone Call

Analogue and ISDN Phones



The doorphone rings your extension



Lift the receiver



Conduct door conversation

Operating the Door opener during a call

Analogue and ISDN Phones



Enquiry

You are conducting a door call



Operate the door opener; it is on for 3 seconds



Enter Extension number of door



Acknowledgement tone



Continue door conversation

Calling the Doorphone

ST 40



Lift the receiver



Press the DOOR button. The acknowledgement tone sounds. You are connected to the doorphone and can speak to the visitor.



Replace receiver

Calling the Doorphone / Picking Up a Doorphone Call

Analogue and ISDN Phones



Lift the receiver



Calling the Doorphone / Picking Up a Doorphone Call



Enter Extension number of door



Conduct the door conversation

Operation

Operating the Door opener directly

ST 40



Notes

A DOOR feature button must be available at your extension if you want to call the doorphone or you want to Call Pick Up a Doorphone or you want to release the door lock.

Communicating a caller's phone number on the internal S0 bus

Analogue and ISDN Phones

When an external ISDN subscriber calls, the telephone system is transmitting the caller's phone number to the called ISDN terminal (ISDN telephone or PC with an ISDN card) on the internal S0 bus. On the ISDN terminal, you can specify that the telephone system adds a „9“ for seizing an outside line before the communicated phone number. If you have stored a phone number in this way, you can dial it automatically from the call list of an ISDN telephone or an ISDN PC.

Outside line seizure - „9“ on / off

Analogue and ISDN Phones

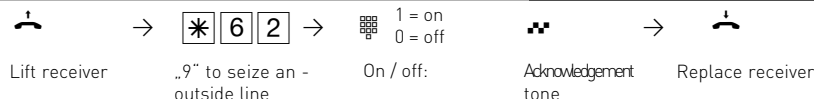

Notes

Analogue and ISDN Phones

This setting is only recommended if you have set „outside line seizure 9“ on the ISDN terminal. This setting is not necessary if you have set „spontaneous outside line seizure with internal“ or „spontaneous outside line seizure“ on the ISDN terminal.

Sending CLIP or COLP

The telephone system transmits your phone number to another ISDN subscriber before the connection is established (default setting of the system). Two types of settings are available within the ISDN network:

Forwarding the telephone number to the called party (CLIP = Connected Line Identification Presentation)

Your telephone number will be forwarded to the subscriber you are calling.

Forwarding the telephone number to the calling party (COLP = Connected Line Presentation)

Your telephone number is forwarded to the subscriber calling you. This ISDN feature will have to be ordered from your network provider.

Operation

Setting CLIP to on/off

ST 40



Press SET 82



Switch on or off

Setting CLIP to on/off

Analogue and ISDN Phones



Lift receiver

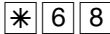

CLIP



On / off:
1 = on
0 = off



Acknowledgement
tone



Replace receiver

Setting CLIP to on/off with a function button

ST 40



Press the "incognito" button to enable or disable sending of your number.

Setting COLP to on/off

ST 40



Press SET 83



Switch on or off

Setting COLP to on / off

Analogue and ISDN Phones



Lift receiver



COLP



On / off:
1 = on
0 = off



Acknowledgement
tone



Replace
receiver

Notes

Your complete number will be send to the network consisting of STD Code and DDI number or STD Code and MSN number, depending if the line is for system access (PTP) or standard access (PTMP). You must transmit a valid number belonging to you. If you transmit a number which is outside your allocated range then the telephone exchange will automatically replace this number with the main number allocated to the ISDN 2 e circuit.

Operation

Diversion from - Divert other Extensions

You can divert other extensions to your own which may momentarily not be staffed. After the diversion is enabled, the diverted phone will not ring for any further calls. Calls can still be made normally from the diverted extension. A special dial tone will remind the diverted extension that a feature is enabled in addition a symbol will be displayed on both phones.

Diversion from - programming and switching

ST 40



Press SET and the DIVERSION FROM button



Enter the extension number you wish to divert to your own



Switch on or off

Diversion from - on

Analogue and ISDN Phones



Lift receiver



Diversion from - on



Enter the number of the phone from where you wish to divert calls



Acknowledgement tone



Replace receiver

Diversion from - off

Analogue and ISDN Phones



Lift receiver

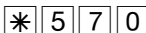

Diversion from - off



Acknowledgement tone



Replace receiver

Notes

Returned Calls, Wake Up and Appointment calls cannot be diverted. Calls can only be diverted once. Calls diverted to you are ringing your extension only even if you have set a 'Diversion to' on your phone. A "Diversion from" a phone where the Do Not Disturb feature has been set to your extension is possible.

Operation

Diversion to -diverting calls to another phone

Diversion via the Phone System

You are able to divert all calls for any phone either to another extension or via the second B channel to any number worldwide.

You are able to select:

- Divert all Calls
- Divert when Busy
- Divert no Answer (after 15 seconds)

The diversion to an external number can also be set up remotely from any number worldwide.

For further set up instruction, please refer to your user manual in the analogue section under the heading 'Diversion – divert to another number'

After the diversion is enabled, the diverted phone will not ring for any further calls. Calls can still be made normally from the diverted extension. A special dial tone will remind the diverted extension that a feature is enabled in addition a symbol will be displayed on the diverted phone and if applicable the internal target extension.

Diversion To - on

ST 40



Press SET 17



Enter the extension number for whom calls should be diverted and confirm with middle button.

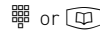

Enter the extension number or outside number to which the calls should be diverted or choose a number from the phone book. To enter a extension number, you have to enter "0" first.



Confirm with middle button

- 1 = All Calls
- 2 = If no answer (divert after 15 secs)
- 3 = When Busy

Select the type of diversion:



Switch on or off



End programming

Diversion To - on

Analogue and ISDN Phones

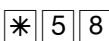

- 1 = external destination
- 2 = internal destination
- 3 = abbreviated dialling destination

Enter the type of diversion destination:



- 0 = off
- 1 = permanent
- 2 = on busy
- 3 = if no answer

Enter the variant of diversion destination:



Lift receiver

Diversion To - on



Enter the phone number or abbreviated dialling destination



Conclude input



Acknowledgement tone



Replace receiver

Operation

Diversion to – enable feature with function button

ST 40



Select this feature by pressing the DIVERSION TO function button the current status will be displayed.



Enable or disable the diversion by pressing the middle button.

Deactivate all Diversions for an Extension

Analogue and ISDN Phones



Lift receiver

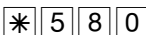

Diversion To - off



Enter the internal phone whose diversion is to be deactivated



Acknowledgement tone



Replace receiver

Delete all Diversions for an Extension

Analogue and ISDN Phones



Lift receiver

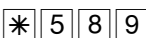

Delete all Diversions for an extension



Enter the internal phone whose diversion is to be deleted



Acknowledgement tone



Replace receiver

Configuring Diversion to from external (example: diversion to - on)

Analogue and ISDN Phones



Lift receiver



Enter the direct dialling in or multiple subscriber number of the switching box



Ringling tone 2 to 3 rings



Wait for 5 seconds internal music on hold



Enter the code number of the switching box within 15 seconds as a DTMF signal

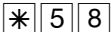

1 = external destination
2 = internal destination
3 = abbreviated dialling destination



0 = off
1 = permanent
2 = on busy
3 = if no answer



Wait for 5 seconds internal music on hold if the code number is correct



Operation

Notes

A diversion will not be carried out if the call to be diverted has already being once diverted. Diversions to an extension where Do Not Disturb is set are not possible. Returned calls, Alarm and Appointment Calls cannot be diverted.

Diversion to external subscriber:

A line must be available for diversions to an outside number.

The diverting extension must have the correct line access level set in order to establish a diversion to an outside number. You will have to pay call charges for diverted calls.

Call Forwarding

Diversion via the public switched telephone network. Call forwarding can only be setup if this feature has been ordered from your telephone exchange. If call forward is carried out on a Point to Point (PTP) connection then the entire line including all DDI's are forwarded.

To forward individual DDI numbers via the telephone exchange and without busying your second B Channel you must have the feature PARTIAL RE-ROUTING enabled in the program of the telephone system.

Using this feature on a Point to Multipoint (PTMP) then partial re-routed does not need to be set as each individual MSN can be diverted. When using a call forwarding button on your phone you can select the line to be forwarded.

Call forwarding can also be programmed remotely from any telephone. For instructions on how to activate call forwarding remotely, please refer to your user manual for analogue extensions under the heading 'Diverting to...'. A destination telephone number must have been programmed if you want to switch on or off call forwarding via a feature button. The following types of call forward are available.

- Forward all calls
- Forward on busy
- Forward on no reply

Operation

Enter Call Forwarding Destination

ST 40

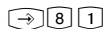

Press "Set 81" to start programming



Select the external number or the name of the line by pressing the arrow buttons and confirm with middle button.



Destination: Enter the external phone number or press phonebook button to choose a phonebook number. Press # to enter a extension number.



Confirm input

"1": permanent
"2": if no answer (after 15 seconds)
"3": on busy

Select Option



Toggle on or off



conclude programming

Call forwarding - on

Analogue and ISDN Phones

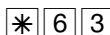

1 = external phone number
2 = phonebook number



0= off
1= permanent
2= on busy
3= on No Answer or Busy



Lift Receiver

Call forwarding

Diversion destination:

Select Variant

Diversion: Enter the system or multiple subscriber number



Destination: Enter the external phone number or phonebook number



conclude input



Acknowledgement tone



Replace receiver

Call Forwarding on / off Single Button Activation

ST 40



Press the button "Diversion to". The trunk line number and diverted number will be displayed as either enabled or disabled. If a general diversion button has been programmed, then the diversion can be selected by using the arrow buttons after the diversion button has been pressed and switched on or off by using the middle button.

Operation

Disable Call Forwarding for a MSN

Analogue and ISDN Phones



Clear Call Forwarding for aMSN

Analogue and ISDN Phones



Enable Call Forwarding Remotely

Analogue and ISDN Phones

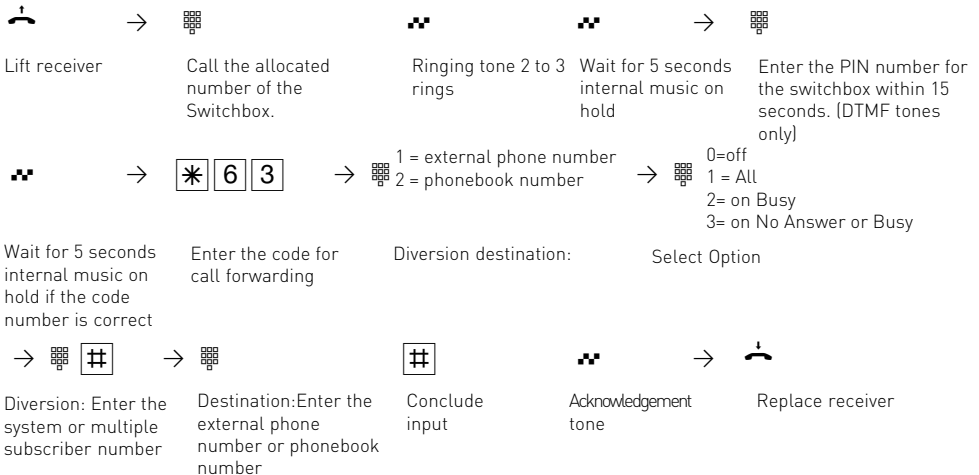

Notes

Call forwarding can be switched on or off via a function button "ISDN Call Forwarding" or by using the programming number "Set 81". Call forwarding can only be programmed if the relevant number is not already diverted. If necessary cancel Call Forwarding. Despite Call Forwarding being active you will be able to make outgoing calls. You will hear a special dial tone from the ISDN exchange. Please note that if Call Forwarding is set up via the exchange that it may take up to one minute till a confirmation tone will be returned. Please ensure that you will not replace the receiver during this time.

Operation

Display call charges

By using a "Units" button, you can display on a system phone the meter total and last call charge per extension.

Display call charges

ST 40



Please take note of display details
enter 4 digit authorisation code
if required



Enter Extension
number

Communication of charge pulses on / off

Analogue and ISDN Phones

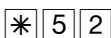

1 = on
0 = off

Lift receiver

Communication of
charge pulses

Enter the digit:



Acknowledgement
tone

Replace receiver

Display charges of the last connection

Analogue and ISDN Phones



Lift receiver

Display charges of
the last connection

Acknowledgement
tone; wait until the
display appears

Replace receiver

Notes

If you wish to display the charges of the last connection by entering , please note that your telephone's totalizer may total up the costs of the last connection.

For technical reasons, the data on the network carrier's invoice may deviate from the total call charges displayed by the telephone system. The charge units counter in the network carrier's exchange is always binding.

IMPORTANT NOTE:

On using analogue lines, call charges cannot be displayed or calculated!

Operation

Print Call Charges

You can print the total of all call charges per MSN line, extension and cost of diversions of doorphones. Printing will be done via a connected serial printer. Depending on the setting printing can be done with either 24 or 80 characters per line. In addition you can select the line feed from 0 to 4 lines. The information printed will contain the date, time, subscribers number, extension or SO number, cost of the connection in units and amount. (If tariff charge units have been entered)

If a Wireless Alarm Controller is in use, then the serial port cannot be used to print call charges.

The print out will automatically be started if an extension user is "checked in / out" by using the relevant function button. The print out will be done via the connected serial printer. Depending on the setting the print out will be in either 24 characters or 80 characters per line. In addition the line feed can be altered from 0 to 4 lines. The print out will include:

- Date, Time,
- Extension Number, Telephone Number and Trunk Line
- Amount of Call Charges in Units and monetary value. (If a value for each unit has been set)

Check in/out

ST 40

Call Charges will be monitored when "Checking in" by pressing the function button "Check in / out". When checking out the call charges will be printed provided a printer is connected to the system and the relevant telephone will be barred from making any further outgoing calls. The function button can be programmed for a specific extension or as a general check out. If the later is used then the extension number has to be entered after pressing this function button. The button "check in / out" does include a separate marker for "Room Cleaned". If an extension has been checked out then the associated LED will flash until the programming procedure *4182 has been entered from the checked out phone. This will indicate that the room has been cleaned and is ready for a new occupation. In any case you still can check in again by using the appropriate function button. By using the arrow keys or the "next" button you can select if the room status should be changed to "Cleaned" or to be booked in again. The selection must be confirmed by using "ok" or "enter". The LED will be constantly on if you check in or off if you select

Operation

Show Own Call Charges

You system telephone can display call charges if it has been set to "Display Call Charges" during a call, or "Display Call Charges" at the end of call. NOTE: Your network provider has to support this feature. You can display:

- Charges for the current call
- available credit, if a amount has been prepaid
- charges for the last call
- Total call charges

Show Call Charges during a Call

ST 40

You are on an external call.

The display call charges with no limit are enabled for your system phone. The charges will be displayed in the first line of the LCD after receipt of a meter pulse for a max 5 seconds. Otherwise the external telephone number will be displayed. You can display the current call charges for max. 5 seconds by pressing the button "Units". At the end of a call the charges for the last call will be displayed for 20 seconds, after which the clock will be displayed. If no call charges are received, then the call duration will be displayed.

You are on an external call.

Display call charges with a set credit limit has been enabled. During the call the current available credit will be displayed for max 5 seconds after each meter pulse has been received. Otherwise the called telephone number will be displayed. You can display the current call credit for max. 5 seconds by pressing the button "Units". At the end of a call the remaining credit available will be displayed for 20 seconds, after which the clock will be displayed.

Call Charges - last call / show amount

ST 40



The receiver is on hook. Press the button "Units"



If on programming of the button "Units" no fixed extension number has been allocated, then you must enter the extension number for which you want to display the call charges.



Close display

The display will indicate:

- Costs and Time of the last call
- Cost and Time of all outgoing calls
- and if a credit has been entered, the remaining credit amount.

Operation

Notes

No charges will be displayed if no monetary value has been entered for a unit

Due to technical reasons the call charges from the network provider may differ from that of the telephone system. Binding will always be the meter in the exchange of the network provider.

The call data must be deleted manually if the call log buffer of the telephone system is full. This may be set in TK Suite under "System Call Log Settings / Call Log Memory" tick the box delete after transfer to TK Bill. Should the buffer be nearly full for system phones which are enabled to display charges, then the message "Read Charges" will be displayed

Operation

System Redial

In the extended redial memory, the telephone system stores the last ten external phone numbers that you have dialled. You can select one of these external phone numbers and you can dial by simply lifting the receiver.

With the automatic redial feature, your system telephone makes 10 attempts to establish a connection to an external subscriber who is busy or who does not answer. If the external subscriber does not answer, the telephone is rung for 30 seconds. The system telephone then cancels the connection attempt. After every attempt, the system telephone inserts a break of 90 seconds. If the other party answers, you must lift the receiver or press the loudspeaker key as otherwise the connection will be cleared after 10 seconds.

You can dial any external phone number by means of the automatic redial function that is displayed when the receiver is on hook. This is the case after dialling preparation, after pressing the „redial“ key or after the „destination“ key or „phonebook“.

Extended Redial

ST 40



With the receiver on hook. Press the "redial" button. The last phone number dialled is displayed.



Select one of the 10 last phone numbers displayed by using the arrow buttons.

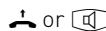

Lift the receiver. The displayed phone number is dialled.

Automatic Redial

ST 40



With the receiver on hook. Press the "redial" button. The last phone number dialled is displayed.



With the receiver on hook press the redial button. The last number dialled is displayed. Automatic redial will start once you press the emiddle button. The LCD will display how many more times the system is trying to the requird number. The speaker will be switched on automatically once the connection has been established.

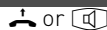

Pick up the receiver or press the speaker button as otherwise the line will be cleared down after 10 seconds.

Notes

A phone number which has been dialled via the single button dialling or the phone book will not be stored in the redial memory. Automatic redial can be cancelled at any time by pressing any button on your system phone.

Operation

Wake Up Call

You can place a Wake Up Call from your phone. The Wake Up Call will ring your phone for one minute with increasing volume. The snooze function can be activated at the push of a button during the wake up call which will then be suspended and repeated every 10 minutes for a maximum of one hour. The wake up call will be completed once you lift and replace the receiver. The Wake up call will ring your extension even if do not disturb is set. A bell symbol will be displayed in the LCD to indicate that this function is set.

Set Wake Up Call

ST 40



Press SET & Wake Up Call



Enter extension number for which the Wake Up Call shall be set.



Enter the time as HH:MM in the 24 hour format and confirm with middle button.



Select the day of the week for which the Wake Up Call should be set:
1-7 for days from Monday to Sunday
8: Monday to Friday
9: all weekdays
confirm with middle button



Switch on or off

Enter Wake Up time

Analogue and ISDN Phones



lift receiver Code to enter Wake Up time

Enter the time as HH:MM in the 24 hour format.

Acknowledgement tone

replace receiver

After entering the wake up time, wake up call is activated for all days.

Set Wake Up Call days from Analogue or ISDN Telephones

Analogue and ISDN Phones

You can specify on which days the alarm will be triggered on your analogue or ISDN telephone after you have entered an alarm time

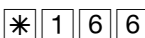

Enter digits, according to the list below



0 = all off

8 = Monday to Friday

9 = Monday to Sunday

1..7 = Monday ..Sunday

You can enter several days in sequence.

Operation

Switch Wake Up Call on / off

ST 40



Press the button Wake Up. The first line of the display will show the stored time. The Wake Up Call will be switched on or off each time the button is pressed.



Press right button to return to the standard display.

Switch Wake Up Call Off

Analogue and ISDN Phones

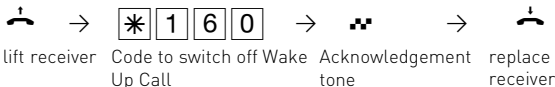

Switch on Wake Up Call

Analogue and ISDN Phones

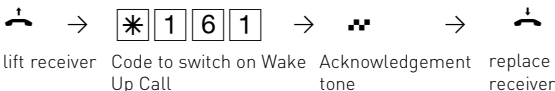

Delete Wake Up time

Analogue and ISDN Phones



Switch off Display Notification on Wake Up Call

ST 40

The wake up call will ring at the preset time. The display will show Wake Up, the set time and the selected Wake Up days. To switch off the display message and wake up call: Lift receiver

To enable the snooze function press any button. The Wake Up call will ring again after 10 minutes. Should a call being in progress when the wake up call is due, then the message Wake Up will be displayed in the LCD with the wake up time and the selected wake up days. The call can be accepted or rejected.

To stop Wake Up call

Analogue and ISDN Phones

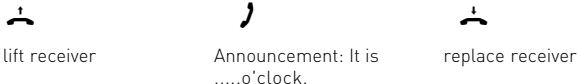

Operation

Receiving a Wake Up Call - activate snooze function

Analogue and ISDN Phones

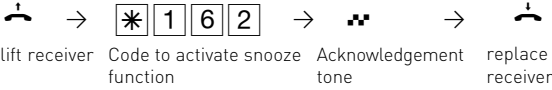

After completion of the procedure 'Continue Wake up call' the phone will ring every 10 minutes for a one hour period.

Notes

The Wake Up call will only work if you have activated it. To switch off the Wake Up Call, press the Wake Up button.

If set to on the Wake Up Call will ring every day at the same time.

The Wake Up Call will not ring your phone if you are on a call, but will ring as soon as you replace the receiver.

Wake Up Call will ring your phone even if you have set a divert for it.

Operation

Single Button Dialling

Your system phone can store up to 20 different telephone numbers. Numbers can be called at the push of a button. Each feature button can be programmed to store a personal number, not accessible from other extensions. Feature buttons can also store numbers from the central phone book. Numbers stored can also be alpha tagged. (See notes on how to alpha tag numbers)

It may have been set in the program of the telephone system which buttons are allocated on your phone for single button dialling. Each function button has two levels. See also Changing function button assignment 2'.

Storing a Number from the Phonebook

ST 40



Press SET & Function Button to be programmed (if you program the button for the second level, then hold the button for at least 1 second)



From the Phonebook select the number required.



Confirm your selection with middle button

Storing a Personal Number

ST 40



Press SET & Function Button to be programmed (if you program the button for the second level, then hold the button for at least 1 second) If applicable a number already stored will be displayed.



Enter the full telephone number you wish to store. You can overwrite an existing entry or press clear to delete the entry first.
Confirm your entry by pressing middle button



Enter a name (see page 1 - xx) and confirm with middle button.
The number stored will only be available to your extension.

Single Button Dialling

ST 40



Lift the receiver and press the destination key. The stored telephone number is displayed and dialled. The outside line is seized automatically. When the other party answers, conduct the telephone conversation in the usual manner

Notes

Enter the number to be stored without the line access digit. The line will be seized automatically.

If a number is already entered in the selected location, then press "clear" to delete this entry. To keep a number displayed, press "stop" and select different button.

Overdialling: Press the required Memory button in which part of the number is stored, and complete dialling by adding the required digits.

Operation

Groups

You are part of a group if your extension number has been allocated to a group number. (please refer to TK Suite).

You can log in or out of the group with a function button programmed as '.GROUP'. The sequence of the call distribution is important (for even call distribution within a hotline for example) and will not change if a group member will log in or out of the group. A maximum of up to 20 groups can be formed and every extension may be a member of every group.

Log In / Log Out

ST 40

Press the button GROUP. If you have been logged into a group the display will show LOGGED OUT FOR GROUP NN. Whereby NN is the group number or group name. If you press the GROUP button again then you will be logged in again and the display will read LOGGED IN FOR GROUP NN.

If you do not specify the group number, then the function will be carried out for all groups you are a member of. The call sequence as defined with TK Suite will not change.

Allocate Extensions to Groups

Analogue and ISDN Phones

For own extension:



For another extension:

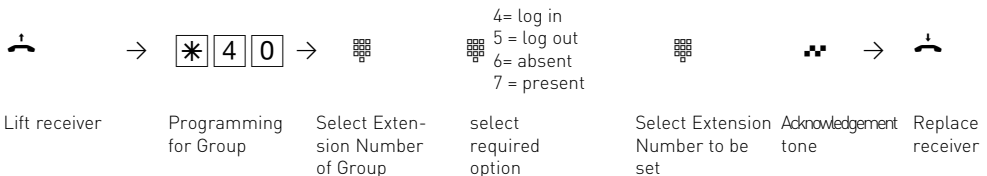

Operation

Account Codes

By Using Account Codes you can assign calls to different projects. The evaluation is carried out by TK-Suite Bill.

Setup Function Button for Account Code

ST 40

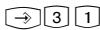

Start Programming



Choose function button



Choose "Project" with arrow buttons and confirm with middle button.



You may either enter a account code up to 6 digits or leave out the account code and confirm with middle button.



End Programming

If you leave out the account code you have to enter an account code every time you want to assing a call to a project via function button.

Allocate Account Codes from ST 40

ST 40

You may assign account codes on your system phone before or after a call. Press button "Propject" before a call or choose the call in the call log after the call and then press button "Project".

Allocate Account Codes from a SLT Telephone

Analogue and ISDN Phones

Account Codes can be assigned from a SLT phone before the call is made:



Lift receiver

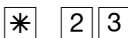

Programming Code



Enter Account Code

Operation

Call Filter

Call filters can be set up for each telephone extension. These filters offer the option that incoming calls from specific numbers or withheld numbers can be rejected, transferred to an answering machine (ST 40 with digital answering machine), transferred to a specific number, or breakthrough to an extension for which the feature "Do not Disturb" or "No Call Waiting" has been set. A VIP call can also be set so that a call from a specific telephone number will have a special ringing tone.

Call Filter Programming

ST 40

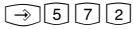

Enter Call Filter Programming



If Phone Book has been selected, then the relevant entry has to be set to which the call filter should apply



Select the filter feature which is to be used, ie. Breakthrough, TAM, Reject etc.



confirm by pressing the middle button

Call Filter Enable / Disable

ST 40



Enter Call Filter Programming



Switch on or off

With this function you will enable or disable all call filters set for that particular extension.

Call Filter Enable / Disable

Analogue and ISDN Phones



Lift Receiver

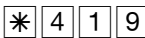

Call Filter



Switch on or off



Confirmation Tone



Replace Receiver

Delete Call Filter

ST 40



Enter Call Filter Programming



Select the appropriate filter by using the arrow keys and confirm with the middle button.



End Programming

Operation







Call Through









Analogue and ISDN Phones





You are able to use the telephone system as an automatic operator to connect your incoming call to another telephone number, be it national, international or even an ISDN over IP call. For this purpose you must allocate a DDI or MSN number to the Switchbox (Phantom Number). This number may also be registered, if available, by your mobile phone provider as a preferred telephone number for which a lower- or no charge may apply. In practise you would phone the dedicated number of your switchbox from your mobile. The switchbox will answer the incoming call and depending on the programming will recognise your CLIP and will return a confirmation tone. Two telephone numbers can be programmed for which the CLIP is going to be recognised, thus eliminating PIN procedures. After having received the confirmation tone from your telephone system you will be able to access your phone book and make an outgoing call using the second B channel of the ISDN line. It may be cheaper if calling from a mobile phone to use this feature then if you would phone directly from your mobile, specially if making international calls. All programming procedures which are initiated by star (*) can be accessed via the switchbox.

Program Telephone Number (Register / Delete) for Switchbox access

Analogue and ISDN Phones

You must start programming mode by entering:  →      







	→	   	→		→	 	→	
Lift receiver		Program mode to enter phone number (ie Mobile)		Enter telephone number of incoming line (ie Mobile)		Finish Entry Confirmation Tone		Replace Receiver

Continue programming or end the programming mode by entering:  →      













Calling your Switchbox (Call Through)

Analogue and ISDN Phones

Dialling directly back out of your system.

	→	 	→		→		→	
Lift receiver		Enter DDI Number of Switchbox. You will hear a confirmation tone once your telephone number has been recognised.		Dial 9 to get a line		Dial required telephone number		Conduct conversation

Dial a Telephone Number from the System Phone Book.

	→	 	→	 	→	  	to	  	→	
Lift receiver		Enter DDI Number of Switchbox. You will hear a confirmation tone once your telephone number has been recognised.		System Phone Book Access		Enter location of phone book entry required		Conduct conversation		Conduct conversation

Operation

Notes

Analogue and ISDN Phones

If you hear busy tone after you have dialled the number required, then this may be because a 2nd B channel is not available from your system or the required telephone number is busy. After approx. 10 seconds the busy tone will be switched off and you can try again an entry from the system phone book by using ***[3]** + entry location.

CLIP - Display Caller Number

Analogue and ISDN Phones

The telephone number of the incoming caller can be displayed on telephones who will support this feature, even before you answer the call. Incoming calls will display the telephone number and the date and time. Calls from extensions will display the name in addition to the number. You must set this feature on the telephone were this feature is going to be used or not used.

Enable CLIP

Analogue and ISDN Phones



*** 7 8 9 2**



0=off
1=on



Lift receiver

Index number for CLIP function

Enter required
Digit

confirmation
tone

Replace Receiver

Extended CLIP Function

Analogue and ISDN Phones

In addition further option of the transmitted caller id may be used. This can be utilised system wide by entering an index number for required feature.

- CLIP off
- Display telephone number
- Display name from phone book (if available)
- Display date & time
- in case of a diversion display the number to which this call was directed. (only useful for answering machines with mailbox feature as a call can be routed to relevant mailbox)



*** 7 8 9 1**



0=all off
1=Display Number
2=Display Name
3=Date
9=Diverted Number



Lift
receiver

Index Number for CLIP
Function

Enter required
Digit

confirmation
tone

Replace Receiver

Keypad function

Analogue and ISDN Phones

To use a keypad function you must prefix the function, ie *123, by "**". The phone system will automatically seize a line and forward the keypad function to the network provider.

Operation

Switchbox

Some system functions may be carried out remotely by dialling the assigned telephone number of your system. The condition is that the telephone you are using to dial in with can transmit DTMF tones. (Touch Tone Dialling)

The functions which can be remotely controlled are:

- Allow remote programming
- Set a time credit for an extension
- Night Service on / off
- Room Monitor
- Switch time on/off
- Set up diversion on/off
- Forward to alternative extension on/off
- Access Call Trough feature

Prepare Switchbox for Remote Access

To gain access to the Switchbox it might be useful to allocate via TK Suite a MSN or DDI telephone number. You also can use one of your own MSN's which are forwarded to the extension number of the switchbox.

Activate Functions Remotely

Your telephone system must be programmed accordingly to set functions and features remotely. It is imperative that the telephone itself which is carrying out the remote setting at the distant end must be able to transmit DTMF tones.

Important: The telephone system will disconnect the line every time an incorrect PIN is entered for the switchbox. After three failed attempts the switchbox will be blocked for 30 minutes.

AIS-Module

Integrated AIS-Module

The integrated AIS Module will add Music on Hold, Advertising Messages, Notifications etc and much more to your Telephone System. Individual messages can be played to callers on hold.

The AIS Module can be configured in such a way that messages can be played before the call is answered, or only if the operator is busy. Therefore it can be used as a call sequencer. The AIS module can also be configured to be used as an Auto Attendant. This way the caller has the ability to connect to an extension or department of their choice.

With the AIS Configuration Tool, which is included with the system, individual messages or music on hold can be uploaded into the telephone system.

In default copyright free music including announcements are already included on the AIS Module and are ready for use. A total of 70 minutes can be recorded on the AIS module. In default 11 minutes are already recorded. Audio files such as information, Advertising or Music be be uploaded into the module.

For musical recordings please observe relevant copyright laws!

With the AIS Configuration Tool you can select individual .wav files or converted MP3 files and assign them to different message types, for example, greetings, music-on-hold, door, sensor and wake up calls. You can create these wave files yourself or obtain them from commercial sources (see standard tunes). Please note, that these wavefiles must use a standard PCM format, 8 or 16 Bit, mono or stereo in sampling rates from 6 to 48 KHZ. These files must be audio files with no additional headers. (Copyright protection)

Wake up calls can be set from any telephone extension on the system. The wake up call will ring the extension at the pre-set time and a message such as "This is your wake up call. The time is....." can be played.

If a door contact or other sensor is connected to the telephone system then an internal or external call can be initiated to a preset telephone number, once the sensor has been triggered, and deliver a spoken message.

You may assign a message to such calls, for example "Sensor door one has been activated." Calls from a door phone may ring differently by using an audio file. Note: This feature is only to AGFEO System Phones.

AIS-Module

Operating

After you have installed the AIS module and have programmed TK Suite Set, start the AIS Configurator. Click on the "Read system" button, the AIS data is read out from the phone system. Please ensure the AIS Configuration Tool is connected to the phone system by using the X.31 protocol. If you are using TK Suite Basic with a permanent X.31 connection, you have to close the TK Suite Server application in order to use the AIS Configurator. The AIS Configurator will offer various messages as well as editing fields.

In the Profile pane, you can:

- Load an existing AIS configuration
- Save a new AIS configuration
- Create a new configuration

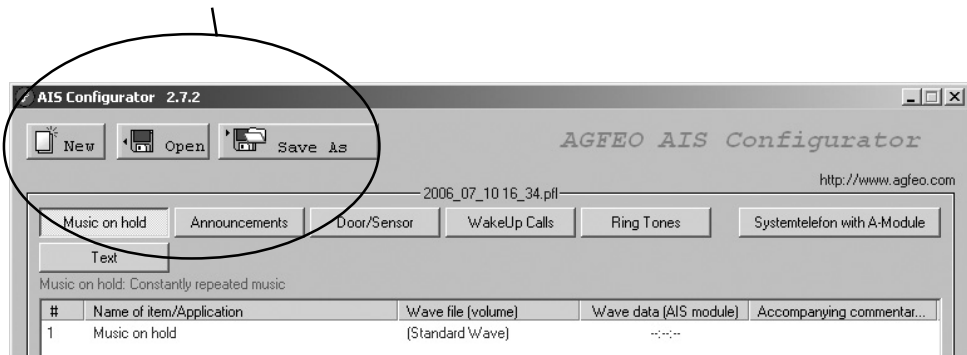

AIS-Module

Operating

If you click with the right hand mouse onto an entry, a drop down menu will open.

In this menu you may select the following:

- select wave file on PC, to be allocated to the AIS Module
- listen to selected WAV file
- delete the selected entry
- enter or delete a comment
- send selected wave file to the system
- delete a wave file in the system
- read out a wave file from the system
- check a wave file in the AIS Module

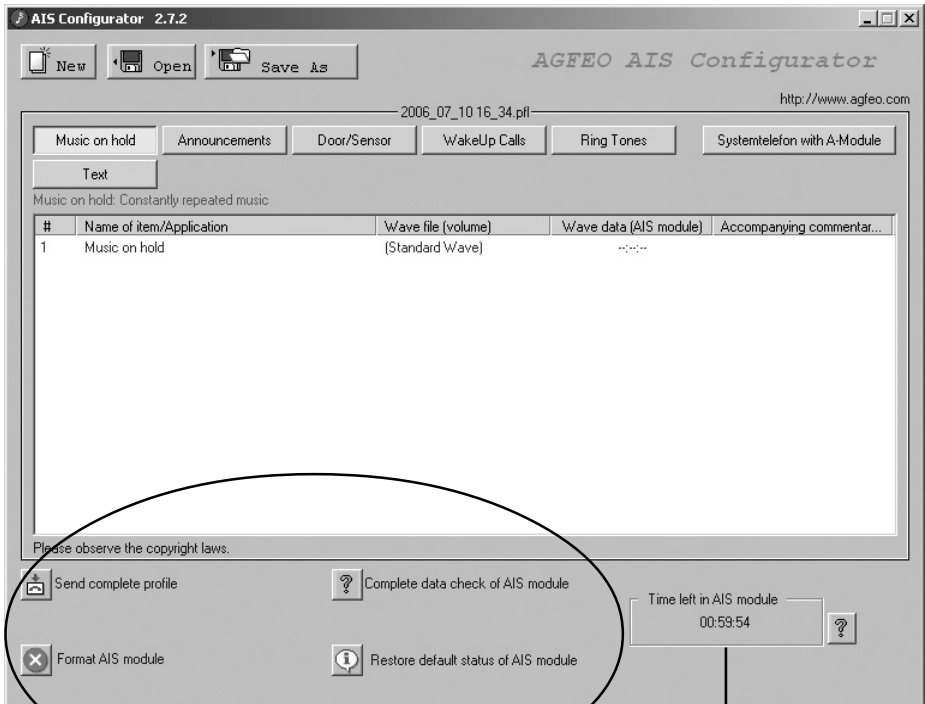

This line displays the available AIS system storage in seconds

In the Communication pane you can:

Select a .wav file on your PC (an index must be highlighted for this)

Send a new AIS configuration to the system

Delete an existing AIS configuration in the system.

Read out an AIS configuration from the system.

You can change a comment in the message pane by double-clicking with the left mouse button which activates the edit mode.

Loading .wav files into the system can be done using either the internal SO bus or the USB connection.

AIS-Module

Transferring Messages and Music-on-Hold

Music on Hold is automatically integrated into your TK system with the AIS-Module. The Music on Hold can be replaced at any time using audio files. This is how you do it.

Music on Hold (MoH)

Audio files allow you to create on-hold music to be played while a caller is on hold or is transferred to another extension.

Changing Music on Hold

Click on the Music on Hold button The following appears in the input screen:

#	Name of Item/Application	Wave file(Volume)	Wave data(AIS module)	Accompanying commentar
1	Music on Hold	name		comment

Click on the first line which will be highlighted.

Click the right mouse button, a drop down menu will be displayed.

Select "Wave File" to listen to the selected file.

Click on select "Wave File" and "open" if you would like to open and listen to files which are stored on your PC.

Click on Commentary to edit or add notes, such as the music title etc. Press enter to store these changes.

The field (line) has to be highlighted before a change can be made to the comment.

Please NOTE: Music on Hold which is to be played from the AIS Module must be enabled via the Configuration Tool TK Suite Set under "Special Functions" "Oher Settings" "Music on Hold".

For musical recordings please observer relevant copyright laws!

AIS-Module

Messages

Greetings

The greeting announcement is played to external callers before they are connected to one of the groups you have defined. For example, the greeting might be used for marketing purposes. As soon as an external call is put in a "Message prior to answering" queue, a seasonal message might be played, for example, "Winter is coming up. Time to think about winter tyres." You can also define whether callers for the group always hear the message, or only if all extensions within the group are busy. You may also specify whether the greeting is played in its entirety before the call is answered, or whether the call can be answered during the message playback. If group members are called as set in your call distribution, a call can be picked up during the announcement.

Applying announcements

Click on the button "Greeting message." The following appears in the input screen:

#	Name of Item/Application	Wave file(Volume)	Wave data(AIS module)	Accompanying comment
1	Announcement	name		comment
...totototo
10	Announcement	name		comment

Click on the first line which will be highlighted.

Click the right mouse button, a drop down menu will be displayed.

Select "Wave File" to listen to the selected file.

Click on select "Wave File" and "open" if you would like to open and listen to files which are stored on your PC.

Click on Commentary to edit or add notes, such as the music title etc. Press enter to store these changes.

The field (line) has to be highlighted before a change can be made to the comment.

On-Hold-Message

When an external caller has received the greeting and has been transferred to the "Message prior to answering Group," the extensions are called according to their notification type.

During the ringing phase, you may specify whether the external caller receives an on-hold message (e.g., "Your call is being transferred") or hears ringing tone.

Applying an on-hold message:

Follow the same procedure as for "Applying greetings." Just click on the "On-hold message" button.

Wake Up Call

Every extension connected to the system can set a wake up call. The wake up call will ring the relevant extension at the pre-set time with a selected wake up message.

If you receive the system configuration via the AIS configuration tool, then eight wake up announcements will automatically be available. Wake up announcements 9 and 10 are blank.

- 1 Wake up announcement before time.
- 2 Wake up announcement after time.
- 3 Announcement for confirmation of wake up time.
- 4 Announcement "Set"
- 5 Announcement if no wake up time is set.
- 6 Announcement "Is not"
- 7 Announcement prior to PIN code entry.
- 8 Announcement on wrong PIN entry.

The correct time will be automatically announced on wake up announcements 1 and 2. You may record your own announcements for this. These announcements will be played automatically upon receipt of a wake up call.

Store Wake Up Announcement:

Follow the instructions for "Greeting" but click on the button "Wake Up"

AIS-Module

Setting the Configuration Tool TK Suite

In order to use the wave files which have been programmed with the AIS configuration tool it will be necessary to make some adjustments in the telephone system itself by using the TK Suite Set configuration tool.

Music on Hold

In the section "Special Functions - Other Settings" the entry Music on Hold with various settings can be found.

Off (Music on Hold is switched off)

Internal Melody (Music on Hold will be played from the AIS module)

Select the required setting and click "Send" to change system settings.

The screenshot shows the AGFEO Administrator Menu / Other Settings window. The left sidebar contains a navigation tree with categories like PBX, Port Assignment, Extensions, Calls Incoming, Calls Outgoing, Phone Settings, System Call Log Settings, Security Settings, Special Functions, and PBX Phone Book. The main content area is titled "Music on Hold" and contains the following settings:

- Music on Hold: Internal melody (dropdown menu)
- Volume for AIS: 1 2 3 4 5 6 7 8 (numeric input)
- Switching Settings:
 - Park in/out with code:
 - Dial 99 instead of "9":
 - Sub PBX Prefix:
 - Enable External Transfer with Hangup:
- Time Settings:
 - Call Return After Transfer (secs.): 45 secs. (input field)
 - Parked Call Return (secs.): 240 secs. (input field)
 - Diversion on No Answer (secs.): 15 secs. (input field)
 - Automatic Dial (secs.): 10 secs. (input field)
 - Time Intervals Redial Attempts (secs.): 90 secs. (input field)
 - Transfer Time to Extension within Hunt Groups (secs.): 15 secs. (input field)
- DTMF digits for VoiceBox Interfaces:
 - DTMF Digits for Recording:
 - DTMF Digits for Enquiry: # (input field)
 - DTMF Digits for Disconnect:
 - DTMF Digits for Call:

Announcement before Answer

It is possible to play a message for up to 2 callers prior to the call being answered. You can select settings for two AIS Channels.

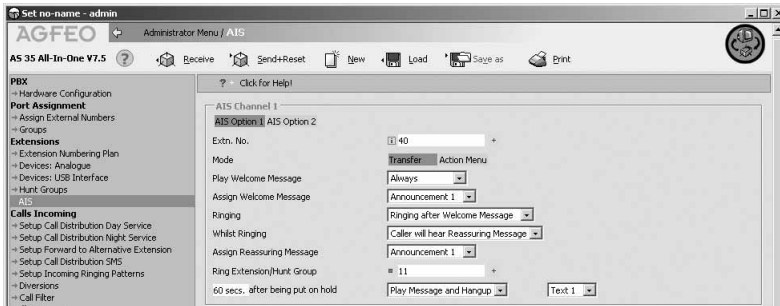

The availability of the AIS channels is limited due to the hardware. Therefore the AIS channels are only available to external lines. Internal calls will not be answered. It is possible to connect an external call to an AIS channel via the selection "Connection without announcement".

Both AIS channels can be configured separately.

Each AIS channel is able to answer one call at a time.

If in doubt both AIS channels should be configured identically.

You may configure the AIS module in such a way that the caller will be able to select functions by pressing the associated button on the telephone keypad. Therefore a caller may

select an extension number or department with the push of a button. To view further settings, please select "Action Menu". The first column will list the available DTMF digits. The second column offers the available function via a drop down menu. In auto attendant mode an AIS channel is only available again after the selected function (action) as been completed.

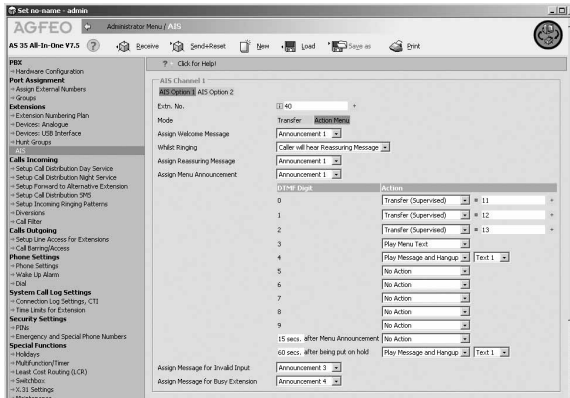

The following options are available:

- "No action" If this DTMF digit is received.
- "Transfer" The call will be transferred to the selected extension- or hunt group number. Should the number be busy, then the caller will be put on hold and listen to music on hold. The behaviour of this feature is the same as the AIS mode Transfer.
- DDI (Direct Dial In) The caller has the ability to transfer the call to an extension of their choice.
- Play Message - A pre-selected announcement will be played back.
- Play Announcement and Hang Up. A pre-selected announcement will be played back, after which the call will be cleared.
- "Transfer - Supervised". The call will be transferred to a pre-programmed extension or group. Should that extension or group be busy then the "Message for Busy Extension" will be played, after which the caller is back in the main selection menu.
- "DDI Supervised" The caller has the ability to connect to an extension or hunt group of their choice. However, should that selection be busy, then the "Message for Busy Extension" will be played, after which the caller is back in the main selection menu. The incorrect selection of an extension number will cause the "Message for Invalid Input" to be played.
- "Play Menu Text" will again play the main menu message.

In addition an "Action" can be set if the caller does not press any digits. In the example above after 15 seconds after "Menu Announcement" the menu text will be played again. In the case the caller is unable to signal any DTMF tones then this can also be set so that this call will be transferred to a preassigned extension.

In the field " 60 seconds after being put on hold" a further action can be selected. For example. If the call has been transferred in "unsupervised mode" and the caller is waiting to be answered, then the maximum time the caller should wait can be selected here. If the maximum selected time has elapsed, then the call could be transferred to a pre selected extension port to which an answering machine is connected. In our example above Text 1 is played after which the caller will be disconnected.

AIS-Module

Welcome Message (Mode "Transfer")

ST 40

The "Welcome Message" can be played for the defined AIS channel

- Always for each incoming call or
- Only if the extension or group is busy.

Please select which mode is going to be used.

Time at which an Extension should ring

When a caller is connected to the chosen AIS channel the selected "Welcome Message" is played.

The caller will be transferred to the extension:

- after the "Welcome Message" is played. The caller will hear the complete announcement after which the call is transferred to an extension or group, or
- during the "Welcome Message". In this case the caller will hear the announcement and at the same time the selected extensions will ring. Once the extension or group answers, the announcement will stop.

Please select the desired mode. Either "Ring after Welcome Message" or "Ring during Welcome Message"

Announcement during Ringing Phase

After a caller has received the "Welcome Message" and will be signalled to the relevant extension as defined in Call Distribution Table you may select if the caller will receive

- ringing tone or
- a further announcement, like Music on Hold with reassuring messages.

Please select your desired setting by clicking onto it.

Allocation of Welcom Message

In the AIS configuration tool you may have various announcements. These announcements will have an index number from 1 to 10. They may also have a note for easy identification purposes. Please select the desired announcement.

AIS-Module

Allocation of On Hold Message

In the AIS configuration tool you may have various On Hold Messages. These messages will have an index number from 1 to 10. They may also have a note for easy identification purposes. Please select the desired announcement.

Allocation of Door Phone Announcements

You may also have various door phone announcements in the AIS configuration tool. Please click on the desired announcement.

Allocation of Sensor Announcements

You may also have various sensor announcements in the AIS configuration tool. Please click on the desired announcement.

Recording of Announcements from Sytem Phones

ST 40

All required announcements can be recorded from a ST 40.

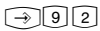

Initiate Programming

- 1= Door / Sensor
- 2=Announcement
- 3=Ringng Melody AIS
- 4=Wake Up
- 5=Music On hold
- 6=Texts

Select which type of text you want to record



Select an index number



With the middle button you are able to listen to previous recordings



Press the middle button again to re-record your announcement.

AGFEO sourced Copyright Free Music and Announcements from:

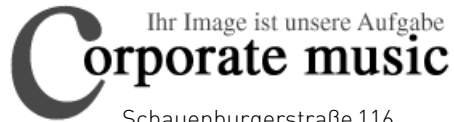

Schauenburgerstraße 116
24118 Kiel
Tel.: +49 (431) 5606370
Fax: +49 (431) 5606371

info@on-hold.de
<http://www.on-hold.de>

Programming

Programming via PC

After installation, your telephone system is prepared to enable you to immediately conduct telephone calls in the usual fashion and to directly benefit from further advantages of the system. However, the system allows diverse programming possibilities so you can configure it to suit your very own personal leads. Without needing to have any knowledge of a programming language, you can program the telephone system from a PC connected via the RS 232 C interface or from a PC with an ISDN card connected via the internal S0 bus. Easily understandable menus guide you through the configuration program. The configuration software is on the included CD ROM.

System requirements

- IBM- or compatible PC with hard disk and CD ROM drive
- Pentium II 233 MHz or higher
- at least 64 MB RAM
- Microsoft Windows 98/2000/ME/XP
- RS 232 C-or USB interface

Configuration Software

-Refer to Communication via PC, Install TK-Suite

Connecting a PC

Connect the telephone system's RS 232 interface (D-SUB-9 socket) to the PC's COM port. Use a 1:1 V.24 plug socket extension lead for connection. It must not be longer than 3 m.

Start the configuration program.

Configure the telephone system. Your inputs are accepted interactively by menu prompting. After completing configuration, remove the cable from the telephone system

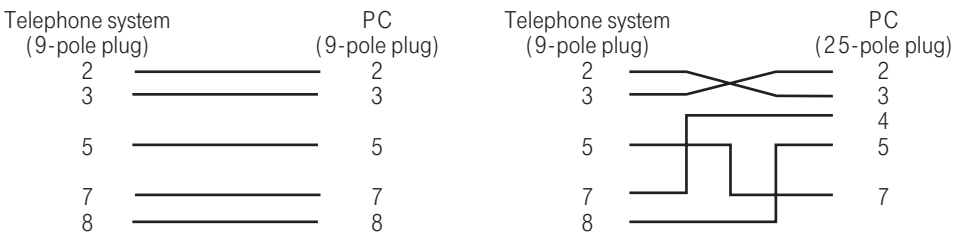



Programming

Programming from the system telephone or a/b telephone

After installation, your telephone system is prepared to enable you to immediately conduct telephone calls in the usual fashion and to directly benefit from further advantages of the system. However, the system allows diverse programming possibilities so you can configure it to suit your very own personal needs. You can execute the programming instructions with the  procedure on the system telephone and on the a/b telephone.

General notes on programming from the system telephone

Initiating programming: the individual programming functions can be initiated in two ways:

- by pressing  and by entering a program number
- by pressing , Scroll with arrow buttons and confirm with „ok“

Pay attention to the display. If the **setup code** is prompted, enter the 4-digit code [see „Protecting functions of the telephone system against unauthorised use“].

The display may show what you are able to enter.

Defined values are embraced in arrows, e.g.: 1 2→3 ←4 5 6 7 (to set the tone ringing volume).

A flashing cursor marks an input location.

To move the cursor to the right: 

To move the cursor to the left: 

Any existing input can be overwritten or can be cleared with „clear“

Confirming inputs: „ok“ or „Store“

Accepting a displayed value without change: „Next“

Clearing inputs: „Clear“ (clear flashing input)

If you ever hear a beep (error tone), you have pressed a key that is not allowed for the current operating step. Have a look at the display to find out which input is required and try again.

Cancelling programming: press „stop“ or „back“ several times (anything you have not confirmed by pressing „ok“ or „Store“ will not be stored).

- Time out: The programming is aborted automatically if you do not press a key for 60 seconds (everything which you have not yet confirmed with „ok“ or „Store“ is not saved).

Ending programming:  (all inputs are stored)

If a call arrives while you are programming:

Lift the receiver. Programming is cancelled.

- Everything you have already confirmed by pressing „ok“ or „Store“ is stored.

- Everything you have not yet confirmed by pressing „ok“ or „Store“ is not stored.

Programming

Notes on programming with * - procedures

Programming with the * procedure always covers the steps:
Start programming mode, input and exit programming mode.

When programming, pay attention to the dial tones or dial pulses in the handset. Wait after entering every digit until the digit has been dialed. Only then will you hear the acknowledge tone if your entry is valid or the error tone if your entry is invalid. Recommendation: Use a DTMF telephone (touch-tone dialing) for faster programming. You can press the loudspeaker button instead of „Lift handset“ or „Replace handset“ when programming on the system telephone.

Starting the programming mode

Analogue and ISDN Phones

To be able to change settings you must first start the programming mode



Lift receiver

* 7 0 5

Start programming mode



Acknowledgement tone or enter setup



Replac receiver

Enter setup code?

If you hear the acknowledge tone after * 7 0 5, no setup code is programmed in the telephone system. It is not necessary to enter the setup code. If you hear the error tone, the last input is wrong. Start the input again from the beginning. If you do not hear any tone after * 7 0 5, a setup code is programmed in the telephone system. Enter the setup code in 4 digits. If the code is correct, you will hear the acknowledge tone. If the code is wrong, you will hear the error tone. Replace the handset and start the whole input again from the beginning with the correct setup code.

Exiting the programming mode

Analogue and ISDN Phones

After you have made all the settings, you exit the programming mode. At the same time you save the new settings. These are retained even in the event of a power failure.



Lift receiver

* 7 0 0

Exiting the programming mode



Acknowledgement tone



Replac receiver

Programming

Adjusting the flash time



Analog telephones with tone dialling need a flash key, among others, to transmit calls (R key or Signal key). To adapt the telecommunications system to the different flash times of the telephones you can program the flash time range for your analog extension in the system. You will find the flash time of your telephone in the telephone's technical specifications.

To test whether the set flash time is correct:

- Set up an external call.
- Press the Flash key.
- If you hear the internal dial tone the time is correctly set.
- If the connection is cut the flash time is programmed too short in the system.

Adjusting the flash time for your own extension

Analogue and ISDN Phones

Programming mode must be started with   7 0 5 !

2 = 50 to 200 ms
3 = 50 to 300 ms
4 = 50 to 400 ms
5 = 50 to 500 ms
6 = 50 to 600 ms



 7 8 8



Lift Receiver

Code for flash time adjustment

Enter code for flash time range

Acknowledgment tone

Replace receiver

Continue programming or quit programming mode with  7 0 0 !

Notes

You can adjust the flashtimes for analogue connections of the AS 281 All-In-One, AS 35 and AS 35 All-In-One

Programming

Setting the ringer rhythm for incoming external calls

Analogue and ISDN Phones

In order to distinguish between calls to different numbers, the phone numbers in the system can be assigned four different ringer rhythms instead of the normal external call ringer. The ringer rhythms are code rings 1 and 2, supplemented by code rings 3 and 4. Programming mode must be started with *705!

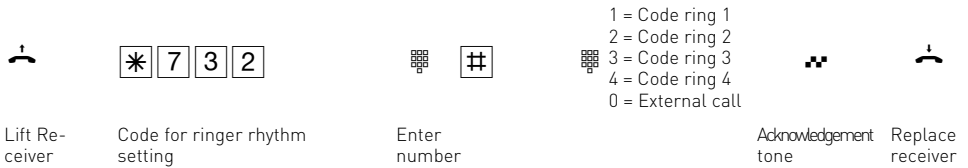

Continue programming or quit programming mode with *700!

Ring rhythms

All ringer rhythms for incoming calls begin with an initial 500 ms pulse, followed by a 2 second pause. This is a technical requirement to allow caller identification (Calling Line Identification Presentation - CLIP). Thereafter the ring can be programmed differently to distinguish between calls to different extension numbers in the system (see diagram).

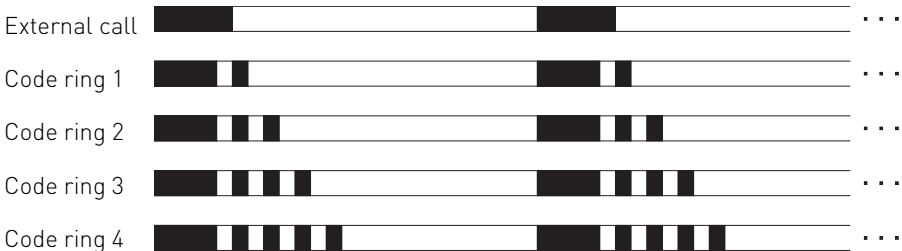

The rings may be different, depending on the terminal equipment in use. The code calls 3 and 4 are not signalled to analog ports that are set to type „radio cell“.

The call times of the TFE's can be set.
You can select the call times freely between 10 and 240 seconds.
This is done by the following code number procedure:

* 7 1 8 6  The call time must be entered in 3 digits (e.g. 010 for 10 seconds)



The repetition mode of the call is also adjustable whereby you can choose between a single call sequence and the option of repeating the call sequence up to the end of the call time:

* 7 3 8 4 8  0: single sequence
1: call sequence repeated up to the end of the call time.

Protecting functions of the telecommunications system against unauthorised use (code numbers)

You can protect some of the functions of your telecommunications system with codes against unauthorised use.

Setup code - normally every subscriber can program.

You can lock all functions reached by  9 or  7 so that these functions can only be used after entering a four-digit code.

You can switch the setup code on and off and change it. The ex-factory code is always 2580, those are the middle keys from top to bottom. The setup code is switched off. You cannot do the setup if you forget your code. Consult your dealer in this case. Only he can reset the code.

Cost code - normally everyone can have the total call costs of all subscribers displayed or cleared. You can protect this function with a code: you can only clear the call costs by entering a four-digit code. No cost code is set ex-factory.

Switch box code - you can dial the switch box of your telecommunications system externally, e.g. switch the relays or perform room monitoring. You can protect the switch box against unauthorised access with the 4-digit switch box code. No switch box code is set ex-factory. You have to enter a switch box code if you want to use the switch box.

Service code - The service code authorises remote maintenance of your system.

This means you do not have to enter your service technician's phone number if he moves, he only has to know the service code of your system and can maintain your system remotely from any location if you have released remote maintenance.

Programming

Enter System PIN

Analogue and ISDN Phones

Programming mode must be started by entering: *705



*7261



Lift Receiver

Enter 4 digit System PIN

Acknowledgement tone

replace receiver

Continue programming or end programming mode by entering: *700!

Delete System PIN

Analogue and ISDN Phones

Programming mode must be started by entering: *705



*7260



Lift Receiver

Acknowledgement tone

replace receiver

Continue programming or end programming mode by entering: *700!

Enter System PIN?

If you hear the acknowledgment tone after entering *705 no system pin is programmed. You don't have to enter one. If you don't hear the acknowledgment tone after entering *705 a system code is programmed. Enter the 4-digit System Pin. If the code entered is right, you hear the acknowledgment tone. If the PIN you entered is wrong, you hear an error tone. Replace receiver and start programming again.

Enter Charge PIN

Analogue and ISDN Phones

Programming mode must be started by entering: *705



*7281



Lift Receiver

Enter 4 digit Charge PIN

Acknowledgement tone

replace receiver

Continue programming or end programming mode by entering: *700!

Programming

Delete Charge PIN

Analogue and ISDN Phones

Programming mode must be started by entering: *705



*7280

Lift Receiver



Acknowledgement tone



replace receiver

Continue programming or end programming mode by entering: *700!

Enter Switchbox PIN

Analogue and ISDN Phones

Programming mode must be started by entering: *705



*7251

Lift Receiver



Enter 4 digit switchbox PIN



Acknowledgement tone



replace receiver

Continue programming or end programming mode by entering: *700!

Delete Switchbox PIN

Analogue and ISDN Phones

Programming mode must be started by entering: *705



*7250

Lift Receiver



Acknowledgement tone



replace receiver

Continue programming or end programming mode by entering: *700!

Programming

Maintenance/ Testing

These functions must only be executed by a service technician.

- Display of the system type and of the software version number
- Setting the countrycode
- Service number define
- System restart (all user data is loaded anew into the RAM).
In this way, in certain circumstances an error can be remedied. All data stored by the user is left unchanged!
- Clearing the memory (**caution: all data is cleared.** Each system has the "as-delivered" settings.)

A system restart and clearing of the memories result in waiting times of around 2 minutes. The display also goes off briefly and programming is ended.

Software Version and System Type

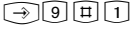

Initiate Programming. Pay attention to the display: You must enter the 4-digit setup code if it is prompted after you enter the number 9. The software version and the system type are displayed.



End Programming

Service Number

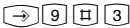

Initiate Programming.



Set 9#1: Initiates Programming. Service number, which is able to remote control, configure or download new software after your permission (→↔).
If is Service number is already defined delete or change it
Enter Service Number



Confirm Input



End Programming

System Reset

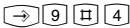

Initiate Programming.



Confirm System Reset
All data is reloaded into Systems RAM, Programming ends automatically or End Programming

Erase RAM

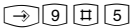

Initiate Programming.



confirm System reset



You have to confirm again.
[All Data will be erased, the System will be reset to delivery settings. This will take approx. 2 Minutes] or End Programming

Software Version of a System Phone

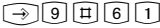

Initiate Programming..Pay attention to the display: You must enter the 4-digit setup code if it is prompted after you enter the number 9. The software version of the system telephone is displayed.



End Programming

Change a System phones extension number



Initiate Programming.

choose extension number with arrow buttons



Confirm selection



End Programming

System phone deregistration

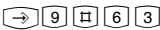

Initiate Programming.



Confirm with middle button, your system phone is deregistered

Status of a STE 30



Initiate Programming, Status of all STEs assigned to your system phone is displayed



End Programming

Logging on a STE 30

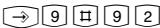

Initiate Programming.



Select an unassigned STE index using the arrow keys and confirm with middle button



Press the lower left function key on the STE30 for more than 2 seconds. The STE 30 is now assigned to the selected index.



End Programming

Logging off a STE 30

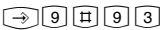

Initiate Programming.



Using the arrow keys, select the index of the STE30 to be logged off and press middle button to confirm. The STE 30 is logged off.



End Programming

Software Version of a STE 30

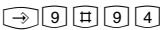

Initiate Programming.



Using the arrow keys, select the index of the STE30 an confirm with middle button. The software version is displayed.



End Programming

Programming

Reset the System

Analogue and ISDN Phones

Programming mode must be started by entering: *705



Lift receiver

*734

Reset System



Acknowledgement
tone



Replace receiver, the System will reset

Continue programming or end programming mode by entering: *700!

Erase the Systems RAM

Analogue and ISDN Phones

Programming mode must be started by entering: *705



Lift receiver

*709

Erase RAM



Acknowledgement
tone



Replace receiver
The System will reset to
delivery Settings

System phone registration

You can run 2 System Phones on every internal S0 of an AGFEO ISDN System. During configuration of the System every phone is registered with a primary and perhaps a secondary extension number.

When you plug a system phone into the system you have to register it.

If you plug a registered system phone of and plug it in on the same S0 after a while, you don't need to register it again.

If you plug it into another S0, you have to register it again.

The extension number can be changed at any time.

System phone deregistration

If you plug a system phone of for use on another S0, you should deregstrate it. Otherwise the extension number can not be used anymore.

Deregistrate system phones with the following procedure: *962

Programming

Changing extension number of a system phone

ST 40



The extension number of your system phone is prompted in the display,



Enter new extension number



Press middle button..

Remote setting - Remote configuration

By means of "remote setting - remote configuration", your specialist dealer can program your telephone system according to your wishes, without having to travel to your house, and simply through your S0 basic access. In doing so, data protection is always guaranteed.

To allow remote maintenance, you should enter into the telephone system the "remote service number" your dealer uses or the "service number" your service center uses to maintenance. Remote service is only possible if the entered number agrees with the communicated phone number.

You also decide when and what is allowed to be programmed. For example, you decide whether the phone numbers in the phonebook can be read and written. If you have allowed remote service, your specialist dealer can read out, modify and write back your telephone system's programming. Remote service remains allowed for 8 hours, after which it is again automatically disabled. For remote service, you may have to end your programming.

Programming

Remote Setting - Remote configuration

ST 40



Initiate Programming



Enter Remote Configuration Number



Confirm with middle button



You can decide if the setting is allowed without, with configuration of the phonebook.



end programming with set, remote configuration is allowed for eight hours.

Enter Remote Configuration Number

Analogue and ISDN Phones



Lift receiver

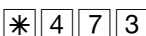

enter remote configuration number



enter remote configuration number



Replace receiver

Allow Remote configuration

ST 40

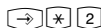

Initiate Programming



Choose with arrow buttons, whether you want to deny remote configuration or allow remote configuration with phonebook or without phonebook. Confirm with middle button.



End programming with set, remote configuration is allowed for eight hours.

Allow Remote configuration

Analogue and ISDN Phones



lift receiver

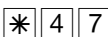

allow remote configuration



0 = deny
1 = without phonebook
2 = with phonebook



acknowledgement tone



replace receiver

Programming

Downloading new software

AGFEO ISDN Telephone Systems can be upgraded to the latest firmware without the need of hardware changes. Your dealer can load the new firmware into the system with the use of a PC connected to the serial or USB port. Telephone systems with a SO connection may also be upgraded using a PC with an ISDN card connected to the internal SO bus. In addition your dealer may also upgrade your system remotely via an ISDN line. Please note that a remote configuration or remote firmware upgrade will not be possible via an analogue exchange line connection.

Programming

Transfer on Hang Up

Should you talk to two external calls, then you are able to connect these by replacing your receiver. This feature will use two trunk lines. To use this feature of external transfer you must enable „Transfer on Hang Up” in programming.

Transfer on Hang Up Enable/Disable

Analogue and ISDN Phones

Programming mode must be started by entering: *705



*73854

1 = on
0 = off



Lift
receiver

Transfer on Hang
Up

Acknowledgement
ton

Replace
receiver

Continue programming or end programming mode by entering: *700!

Programming

Advanced Users Programming

You can reach each program directly by pressing  and by entering the program number. You do not need to remember the program numbers. If you are experienced with programming trees, you can also navigate in the programming tree by pressing "OK" and the arrow keys.



The programming tree is illustrated on the next pages.

Index Register:

In addition to the programming tree, the your telephone system offers you an Index Register, where all functions are sorted in alphabetical order. With pressing and holding „Set“ on your ST 40 for at least 1 second the Index Register is activated temporarily.

Programming tree- rules for use

ST 40

You initiate programming by pressing the  key. If necessary by pressing the  key several times, you can then reach the program point you are looking for.

Every program has a program number. With this number, you can move directly to every program point, e.g. „do not disturb“ has the number 12 (1 from the first level and 2 from the second) and you can move directly to „do not disturb“ by pressing „set 12“.

Initiate programming



Scroll to the next program point



Move back by one program point



or

enter the required program number, e.g. 12, do not disturb

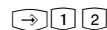

Move back by one level



Cancel programming: Press right button several times



or

end programming „set“



Programming

Programming tree



1 Function

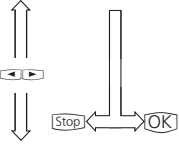

- 1 Call Variant 2/ Dorr Call Variant 2 (Nightservice on/off)
- 2 Do not Disturb (internal/external, on /off)
- 3 Telephone Lock (on/ off)
- 4 Call waiting (on/ off)
- 5 Appointment Call (Time/ Date and activate)
- 6 Wake Up Call (Time, on/ off)
- 7 Diversion to (to extension / externalno., on/ off)
- 8 Diversion from (from extension, on/ off)
- 9 Call forwarding (on / off)
- 0 Room Monitor (on/ off)
- *Automatic Dialling/ Hotline (on/ off)
- # Busy on Busy (on/ off)

2 System Phone Settings

- 1 Ringing Volume (Set)
- 2 Ringing Tone or Pitch (Set)
- 4 Remote dialling 1 Remote Dialling (on/off/extension)
- 2 CTI-dialling (on/off)
- 3 Automatic Call (on/off)
- 4 Automatic Mike (on/off)
- 5 Accustik Settings 1 Speaker Volume
- 2 Reciever Volume
- 3 Headset Volume
- 4 Mike Volume Handsfree
- 5 Mike Volume Receiver
- 6 Mike Volume Headset
- (enter)
- 7 Telephone Lock (PIN) 1 S0 Status
- 8 Cost Display 2 internal Status
- 9 Status Display 3 Worldtime Clock
- 1 S0 Status
- 2 internal Status
- 3 Worldtime Clock
- 0 Display language 1 external
- * Call Log 2 internal
- 2 internal
- # External Line access 1 direct access
- 2 Call with receiver on hook

3 Buttons / Names

- 1 Change Button assignment
- 2 Change extension Name

4 Destination Button

- Destination Button (Number / Name)

5 Phonebook

- 1 Phonebook store a number (Number / Name)
- 2 Phonebook change a number (Number / Name)
- 3 Phonebook delete a number (Number)

Programming

Programming tree

	4 Enter Emergency Number	(Number)
	5 Enter Direct Call Number	(Number)
	6 Enter Automatic Dialling Number	(Number)
	7 Call Filter	1 Filter Activation
	2 New Call Filter
	3 Delete Filter
6 TAM/SMS	Refer to Manual A -Module 30 or A-Module 40	
7 Charges	Own Charges	
8 ISDN- Functions	1 ISDN call forwarding	(always/on busy/ on no reply)
	2 Clip	(on/ off)
	3 COLP	(on/ off)
9 Configure System	1 Enter extension Numbers	
	2 Record AIS Announcements	1 Door Message
	2 Message Prior to Answering
	3 Ringing tone AIS
	4 Wake Up
	5 Music On Hold
	6 Texts
	# Maintenance/ Test	1 Firmware-Version
	3 enter Service Number
	4 System Reset
	5 Erase RAM Reset to delivery defaults)
	6 Systel Menu
	1 Version number
	2 registration
	3 deregistration
	7 DECT
	1 Handsets
	1 registration
	2 Specific registration
	3 deregistration
	2 Headset
	1 registration
	2 Specific registration
	3 deregistration
	4 Alloctaion
	3 Base Stations
	1 Version
	2 Update

Programming

Programming tree

..... 9 STE
..... 1 Status
..... 2 registration
..... 3 deregistration
..... 4 Version number

*** Remote configuration** Remote configuration 1 Enter number
..... 2 allow

Version Version (System Type / Firmware Version)

Communication via PC

Software Overview

The enclosed CD-ROM contains the following software: TK-Suite Basic, the TAPI-, USB and NDISWAN drivers for the AS281 All-In-One, AS 35, AS 35 All-In-One. To be friendly to our environment we have not included printed version of the individual programs as help will be available in each program by just clicking on the question mark.

System requirements

Following system features are required for the installation of the enclosed software

- IBM or compatible PC with hard disc and CD-ROM drive
- Pentium II with a processor speed of 233 MHz or higher
- 64 MB of available hard disc space
- Microsoft Windows 2000/ME/XP

Should you like to run TK-Suite with several clients then we would like to suggest to use Windows 2000 or XP as platform of your server installation.

TK-Suite Server

TK-Suite Server contains the following components, TK-Suite Set, TK-Suite Bill and TK-Suite contact. TK-Server is a program which runs in the background under Windows ME and as a service under Windows 2000/XP. This means that you do not work directly with the program but with the TK-Suite-Client and an Internet Browser application.

Communication via PC

TK-Suite Set



You can program the telephone system from your PC with **TK-Suite Set**. Call forwarding, ringing rhythms, day/night service and all ISDN parameters can be set quick and easy. With **TK-Suite** set you can save the telephone system configuration on your hard disc. If required you can send this back up data back to the telephone system. [see Chapter "Programming of the Telephone System"]

With the **LCR** component of TK-Suite Set you will be able to reduce call cost of your telephone system, provided your LCR table is kept up do date, by using the most cost effective service provider. Should this line be busy, then the automatic fallback function of the system will automatically select the next alternative service provider. A individual routing table can be created at any time to ensure cost effective phone calls. Should you like to take advantage to use a provider on a "call by call" * selection, without being registered to this or having an account, then this is also no problem. Up to eight providers with their dialling codes can be selected in a weekend profile. In addition you can select up to eight tariff tables.

*Network dependent

TK-Suite Bill



TK-Suite Bill is for the analysis of your call data. If your service provider should forward call charge information, then the software will record all call charges. TK-Bill will sort and calculate per extension, date, telephone number or customer. In addition a sort of all calls per providers is also available. TK-Bill will not only record calls cause a charge, but also records incoming calls.

TK-Suite Contact



TK-Suite Contact is your personal telephone and address book with multi user functionality. It is possible to import the phone book data of the telephone system into TK-Suite Contact. It works closely together with TK-Suite Client to give you a fully functional CTI working environment.

TK-Suite Client



TK-Suite Client serves to integrate all TK-Suite components in your desktop so that it is possible to access each tool per mouse click. In addition TK-Suite Client offers you a fully functional CTI workplace with the ability to call telephone numbers from TK-Suite Contact, display incoming calls and reminders with the resubmission function.

Communication via PC

Install TK-Suite

Start the installation routine of TK-Suite.

After you selected the installation folder and start up group, you will be asked from the TK-Suite Basic installation routine if the application should be installed as Single Work Station, Server – or Client version.



Select **Standalone** if you would like to use the Telephone System with one PC only.

Select **Server** if you would like to use the Telephone System with more than one PC.

Select **Client** if you would like to use the Telephone System with more than one PC and have already installed the Server Version to which you have access. Please ensure that the User Setting has already been prepared on the Server for the Client.

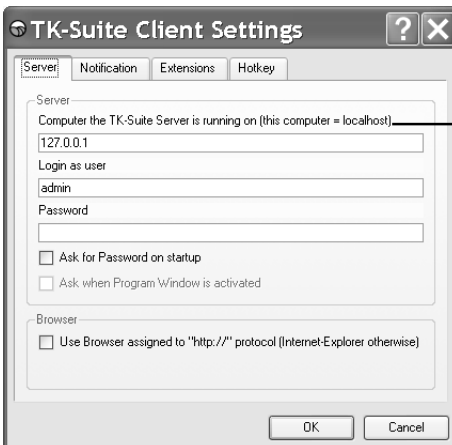

You will be asked for the Server Name, User Name and Password if you install TK-Suite Client to access TK-Suite Server on the network. Name and Password should have been allocated before in the TK-Suite Server version.

Communication via PC

Install TK-Suite

You select between an active an passive connection on installing TK-Suite Basic.

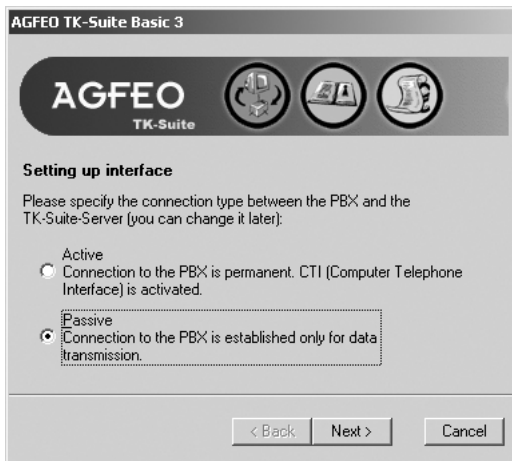

ACTIVE:

The connection to the Telephone System is permanent and the port to which the computer is connected is constantly in use and not available for any other application. A sensible choice for a Server or Single User if the CTI application should be used constantly.

PASSIVE:

The connection to the telephone system will only be established on programming or transfer of call charge data. The port may be used by other applications when not in use.

CTI is **not** possible with this setting.

Afterwards you may select the type of connection to the system:

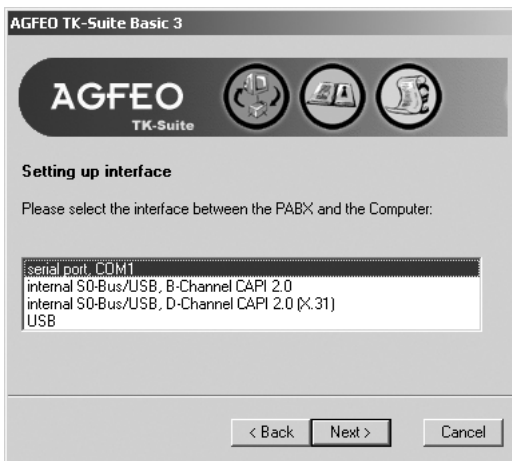

- Com1 or Com 2 if you want to communicate via the serial port with the system.
- Internal SO/USB Capi 2.0 if you want to communicate via the USB or ISDN connection. This type of connection does not support CTI and will not be offered if you have selected "Active" before hand.
- X31 if you want to communicate with the system via the internal SO or USB connection and not to engage a speech channel of the internal SO of the system.
- USB is for use with Com-Line products only.

To use CTI you must communicate with the system either via the serial port or via the X31 protocol.

Communication via PC

WAN Miniport

WAN Miniport is a driver for Windows 98 with which you can use the remote data transmission network via ISDN. Here you can connect to the Internet and interconnect computers (via the Remote Access service). You will find further information about the remote data transmission network in the Windows 98 documentation

CTI - computer-aided telephony via the TAPI interface

TAPI (Telephony Applications Programming Interface) is, unlike TK-Suite, not an autonomous CTI application but an interface between a TAPI-capable Windows application and the telecommunications system. If programs (applications) support this interface it is possible to control the telecommunications system. The scope of control depends on the application being used. However, it usually embraces the starting of outgoing calls (dial from the application) and display of incoming calls.

The TAPI is an interface of the Microsoft operating systems and the application side of the Microsoft Telephony interfaces. A Telephony Service Provider (TSP) from the manufacturer of the ISDN hardware - in this case AGFEO - is necessary to connect this interface. The TSP is a driver which you have to install on your PC. It performs the desired TAPI functions and controls the necessary data exchange between the PC and the telecommunications system. The TSP has to be updated continuously because of the constantly growing scope of functions of the TAPI supporting applications. To ensure you always have the latest TSP for your use we provide the TSP on our homepage in Internet under [http:// www.agfeo.de](http://www.agfeo.de).

The self-unpacking file contains all the information for installation and the supported applications. If you have no Internet access, contact your dealer or the info line fax: +49 521 4470998555

Making the USB connection

You can connect the telecommunications system with a desktop PC or notebook via the USB interfaces.

1. Take the USB cable provided. You will recognise it from the USB symbol on its plugs.
2. Plug the square plug (B plug) of the USB cable into the USB socket on the telecommunications system.
3. Plug the flat plug (A plug) of the USB cable into one of the USB connections on your computer.
4. Switch on your computer.

When you start Windows with the telecommunications system for the first time you will be prompted to state the position of the drivers. You can find out more about this in the „Driver software“ section.

Communication via PC

Installing drivers

Important Note! If you have already installed an ISDN card of another manufacturer in your computer you have to remove this and the drivers first. Follow the instructions in the manual of the respective manufacturer.

During installation, you may be prompted to insert the operating system CD. Keep your operating system CD close by. Before you install the driver software, the telecommunications system must be connected to the PC via the USB interface.

1. When the PC has recognised the connected telecommunications system, the hardware wizard appears. The hardware wizard installs the software for a new hardware component (AS 281 All-In-One/ AS 35/ AS 35 All-In-One). Click „Next”
2. In the following dialogue window select: „Search for the best driver for the device (recommended) and click Next
3. Activate the „CD-ROM drive” option in the following dialogue and deactivate all other boxes. Insert the „Communication software” CD with the USB drivers in the CD-ROM drive and click Next.
4. After the driver has been found, click Next to start installation.
5. The drivers are installed.
6. Read the information under „ISDN configuration” and click „Next”.
7. Select the D-channel protocol: „DSS1: Euro-ISDN” and click „Next”.
8. Now you are prompted to enter the phone number(s). Enter the internal number(s) at the USB access. All internal phone numbers are available (see system programming under port assignment). Click Next.
9. The ISDN configuration is terminated. Click „Finish”.
10. Insert the operating system CD when prompted to load the USB support. After the software for the new device has been installed, click „Finish”.
11. Restart your PC to complete installation.

If you want to change the phone number(s) for the PC at the USB access later:

Select „ Start → Programs → Accessories → Communication → Wizard for ISDN configuration”.

1. Read the information under „ISDN configuration” and click „Next”.
2. Select the D-channel protocol: „DSS1: Euro-ISDN” and click „Next”.
3. Now you are prompted to enter the phone number(s). Enter the internal number(s) at the USB access. Internal phone numbers 20 to 29 are available (see system programming under port assignment). Click „Next”.
4. The ISDN configuration is terminated. Click „Finish”.
5. Restart your PC to complete installation.

Communication via PC

Uninstalling drivers

If you do not want to use the driver software on your PC any longer you can uninstall it. Remove the AS 281 All-In-One / AS 35 / AS 35 All-In-One in the system manager (you will find this under Windows/System Manager/Software/Uninstall/AGFEO).

Glossary

Answering station - VST

The answering station controls your ISDN connection. You can use some functions such as the ISDN call forwarding or the ISDN-hold via the answering station with the ISDN features.

Appointment - wake-up

The system telephones remind you of a fixed appointment (date/time) with the appointment call and flashing LED. With a wake-up call the system telephones wake you every day at a fixed time.

Automatic dialling

When this feature is activated, your telephone system automatically calls the previously entered number when you lift the handset and do not press any other key for 10 seconds. The number is dialled up to 12 times at one minute intervals until a connection is made.

Busy On Busy

This feature of the telecommunications system causes the whole line to be busy when a subscriber is holding a conversation from a call variant/call distribution. Unlike camp on protection, this function works for a complete phone number (MSN) not just for one subscriber.

Call by call

With the call by call feature you can select a desired network provider for a long distance call. You have to set up a call by call function key.

Call diversion - diversion to

All incoming calls can be diverted to a specific external or internal destination telephone. Unlike call forwarding (ISDN) in which there is no connection to your ISDN telecommunications system, the call diversion to the external subscriber uses a second B-channel to reach the desired destination. This may even save money because the Least Cost Router can be used to make the connection. Two B-channels are occupied during the all diversion.

Glossary

Call forwarding - ISDN call forwarding

With this ISDN service feature, calls for your ISDN connection can be forwarded worldwide to any other connection. You enter the destination number in your ISDN telecommunications system and activate the call forwarding in your public exchange. The exchange then re-routes all calls without the telecommunications system noticing (see call diversion). With call forwarding on the system connection you always forward the whole connection. On a multipoint connection you can divert every phone number (MSN) individually to a respective different destination. Call forwarding is possible in the variations permanent, when no answer and when busy. The call forwarding feature can only be used by special agreement with your network provider.

Call list

The call list stores external calls with transmitted phone number with phone number and date/time if the call cannot be answered. On the system telephones and many ISDN telephones the call list can be called at any time and the subscriber called directly by pushing a key. Any phone number can be dialled by a mouseclick from the call list of TK-Suite.

Call variant

The internal phone numbers of the terminal that are rung in the event of an external call are defined in a call variant. Different call variants can be defined for the day or the night service. Call variant 1 (day time service) and call variant 2 (night service) can be switched over at any time from any telephone.

Camp on protection - reject camp on

Camp on tones during a telephone call signal that another subscriber is calling. The first caller can be held in the line while you ask the second caller what he wants. This means no calls are missed. Anyone who considers this as a disturbance can switch it off with the camp on protection. The second caller either gets the busy tone or lands on an answering machine for example.

Charging shell switch

With the charging shell switch it is possible to switch functions in the telecommunications system by inserting and removing the DECT 30 in and from the charging shell. The switching can be done for any subscribers. For example the answering machine can be switched on or the call variant changed by removing the DECT 30. The functions for the charging shell switch are set up with the PC using TK-Suite (DECT options).

Glossary

Code numbers

Every connected telephone can be protected against unauthorised access by a 4-digit code (telephone lock) so that with the exception of direct numbers, emergency numbers and automatic dialling only internal numbers can be dialled. No code numbers are entered ex-factory.

Connection data records - call data records

Your ISDN telecommunications system sets up a connection data record for every external call. This tells you that an internal subscriber has made an external call at a certain time on a certain day under a certain MSN for a certain time. This may have caused a number of units and the associated costs, the latter providing call costs are transmitted. Under Registered connections in the configuration program TK-Set you have the possibility of registering either outgoing, none, incoming or all connections. If the connection data records are not printed directly via the serial interface on a printer 100 to 2000 entries are saved depending on the system type which can then be evaluated by TK-Bill (part of TK-SET).

Pop Up menu

The context menu offers you functions which appear useful at the time, e.g. you will be offered the refer-back and disconnect functions when telephoning. It simplifies operation, you do not have to set up a function key for every function which appears reasonable.

Charge code

In principle, every subscriber of your ISDN telecommunications system can clear his call costs. You can also lock out this possibility by entering a four-digit code. No cost code is set ex-factory.

Dialling line (B-channel/S0 basic access)

You can connect an external S0 basic access to your ISDN telecommunications system. Every external S0 basic connection behaves like two conventional analogue dialling lines. You therefore have two dialling lines (B-channels) on which you can make external calls (local, long distance or international).

Glossary

Dialling preparation

The dialling preparation enables you to first enter a number and then activate dialling by lifting the handset. This also applies for phone book and redialling.

Direct call - baby call

The direct call only works when the telephone is locked. Regardless which key is pressed, only the previously programmed phone number is dialled.

Divert from

You can divert all calls of other telephones individually to your telephone. You can telephone as normal from the diverted telephone. On lifting the handset a special dialling tone reminds you that the diversion is activated.

Do not disturb

Calls are no longer signalled acoustically when this feature is activated in the telephone. You can select whether only the internal calls, only the external calls or all calls are not to be signalled. However, internal calls are still signalled optically on the system-internal system phone.

Door handsfree device (TFE)

Door intercom with bellpush and door opener which can be connected to your telecommunications system. You can talk to a visitor at the door and open the door from your telephone.

DTMF post-dialling

For all existing external connections, including refer-backs, brokering and during a three-party conference, it is possible to post dial digits and characters (1 ... 0 , * and #). With the „Remote scan“ key stored DTMF tone sequences can be post-dialled, e.g. for remote scanning of an answering machine.

Dual tone multifrequency dialling (DTMF)

Every dialled digit is assigned a specific tone. Telephones that operate on the basis of this dialling method require a signal key (inquiry key R)/flash function on the telephone system.

Glossary

Emergency call numbers

The emergency call numbers can only be dialled with the system telephone lock activated. When the handset is on the hook you only need to press the Alt key plus asterisk * (emergency call 1) or # (emergency call 2) and confirm with OK to start dialling.

External dialling

External dialling means that you can make a call for another subscriber. For example the secretary for the boss or the ST 30 for the DECT 30.

Identifying malicious callers - tracing

The „Malicious call tracing“ feature can only be used by special agreement with your network provider. The ISDN exchange stores the number of the caller, your number, the date and the time of the call. You can have the caller identified during the call. You activate this procedure on the system telephone with the „Trace“ function key. A key combination is used for this on analogue telephones.

Intercom function - announcement - intercommunication

The connection of the system telephones (ST20/ST25/ST30) replaces an intercom system. When a system telephone is called, the microphone switches on automatically (if programmed) enabling you to talk and listen. If you have not switched on the automatic microphone you have to use the handset or the loudspeaker key for intercommunication. The microphone is not activated when an announcement is made to several telephones. Announcements to system telephones can also be made from normal telephones. Please refer to the operator manuals for analogue terminals - Announcement for a description of this procedure.

ISDN-hold

The ISDN-hold feature is only available at the multipoint connection. You can have your external call held by the ISDN exchange to hold a refer-back conversation with a second external subscriber on the same line. Then you can switch back to the first call. You can also switch between the two calls (broker) or start a conference in the exchange.

Least Cost Routing - LCR

You can reduce your call costs with the Least Cost Routing by using the respective cheapest network provider. With the TK-LCR software every subscriber can set up his individual table for cost-optimised telephoning or load existing tables in the system. Up to 8 providers must be entered individually by a profile. In addition, 8 areas, e.g. city, region 50, German, Euro I, mobile etc. can be freely defined.

Glossary

Module slot

Modular telecommunications systems have module slots.

Phone book

The telecommunications systems save external phone numbers and names in the phone book. System and value added telephones can use the alphanumerics of the phone book. Analogue telephones can dial the phone numbers with the speed dialling numbers. If a phone number is transmitted with an incoming call and this is in the phone book, the display of the system telephone displays the name instead of the number.

Phone numbers

An external phone number is the number transmitted to outgoing external connections. An internal phone number is the number of a subscriber under which he can be reached internally on your telecommunications system. A phone number is the number (MSN) assigned to you by your network provider.

Private destination

You store a private, individual phone number which is only stored on your telephone under a private destination key.

Public destination

You store a phone number from the telecommunication system's phone book which you want to call very often quickly under a public destination key.

Relays

The relays may have on/off or impulse functions depending on the programming. In addition they can be assigned internal numbers and control additional bells or beacons. The relays can also be controlled remotely.

Seizure

Seizure of an outside line (B channel) to call an external subscriber.

Setup code

Normally every subscriber can make settings on your system. You can lock all system-relevant functions so that these functions can only be used after entering a four-digit setup code. You can switch the setup code on and off or change it. The code is set ex-factory to 2580.

Glossary

Speed dialling - destinations in the phone book - according to numbers

Phone numbers of certain external subscribers are stored in the speed dialling memories. Every memory slot has a speed dialling number under which the external phone number is stored. The system converts the speed dialling number into the full number when it is called. All extensions can dial phone numbers from the central speed dialling memory.

Status display - busy display

The system telephone display indicates how many lines are free and whether special functions (call variants, call list and others, call diversions) are activated. A busy display of the internal subscribers is also possible.

Telephone lock

You can protect your telephone against unauthorised use by locking it. If your telephone is locked you can only call internal subscribers, answer all incoming calls and switch internally, dial the stored direct numbers externally, dial the stored emergency numbers externally and perform external automatic dialling. If you have programmed a telephone code for your telephone you have to enter your 4-digit code to unlock it.

Timer

The telephone system has timers that can be used to activate certain functions at specific times. The following features can be time controlled:

- AIS announcement text
- Busy-on-busy
- Call barring
- Call Distribution by Day / Night
- Call Distribution Door
- Call Distribution Forwarding
- Diversion
- Do not disturb
- Hunt group mode
- Phone lock
- Phonebook Macro
- TAM

You can assign one or more functions to any timer. Up to 10 functions can be switched by timers. The timers can only be programmed in the "TK-Suite" program.

Transfer

With the Transfer function you have the option of transferring an external call to an external subscriber. Two dialling lines (two B-channels) are occupied.

Your subscriber connection is charged for the external connection you set up. You can set up the Transfer function key on the system telephone, on the analogue telephone you use the code number procedure.

What to do in the event of malfunctions

Checks

- In the event of malfunctions on the telephone system, please check your operating actions by referring to the instruction manual.
- Check whether the connectors of terminals and of the telephone system are inserted correctly.
- If you cannot remedy a malfunction, your dealer will be please to help you.

Deactivating the special dial tone

Analogue and ISDN Phones

When you lift the receiver on your standard telephone, you hear the special dial tone. You hear the special dial tone when do not disturb, automatic dialling or a diversion is active. You can deactivate all functions that result in a special dial tone by entering a code.

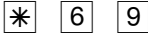

Lift handset

Deactivate special dial tone functions



Acknowledgement tone

Replace handset

Power Failure

- If the power should fail, you can make neither external nor internal telephone calls.

When the power returns:

- The telephone system functions again according to the previously set program. All settings made via the programming mode or the PC program remain stored provided the programming mode was ended appropriately.
- Initiated return calls are cleared.
- Connections parked in the telephone system are cleared.
- The redial entries are cleared.
- The total connection charges and the connection records are stored.

What to do in the event of malfunctions

What to do in the event of malfunctions

<u>Malfunction</u>	<u>Possible causes</u>	<u>Remedy</u>
Telephone system programming unclear		Reset the telephone system Reset the telephone system to the „as-delivered“ settings and reprogram it
No dial tone after lifting handset	Power failure Terminal defective Incorrect installation	Check mains connection/fuses Check terminal on another connection Check connections at the connection socket and on the telephone system
No internal calls arrive	Do not disturb (special dial tone) Diversion to another telephone (internal/external) (special dial tone)	Turn off do not disturb Turn off diversion to
No external calls arrive	Do not disturb (special dial tone) Diversion to another telephone (internal/external) (special dial tone) ISDN call forwarding is active Point-to-point connection: System phone number missing Point-to-multipoint connection: - MSN missing - MSN-internal user assignment missing	Turn off do not disturb Turn off diversion to Deactivate ISDN call forwarding Enter the system phone number Enter the MSN Assign the internal user to the MSN(ringing distribution)
Forwarding an external call (inquiry) is not possible	The inquiry key [R] on the telephone is set as an earth key Wrong flash time	Set the telephone to DTMF and set the inquiry key to flash Adjust flash time on the phone or on the respective port of the PBX.
Distorted speech connection	S0 bus incorrectly installed Connection error	Connect wire pairs correctly

What to do in the event of malfunctions

Resetting the telephone system

By resetting, you can restore the telephone system's programming to a defined state. This may be necessary if you wish to reset unclear settings or if you wish to reprogram the telephone system.

After a reset, the telephone system again operates according to the previously set program. All settings made in the programming mode or by means of the PC program are retained provided the programming mode has been ended properly.

Important: the following are cleared when you reset the telephone system. - All existing internal and external connections

- Remote support
- Internal return calls
- ISDN callback on busy
- Outside line reservations

Hardware reset - unplug the 230 V power mains plug and then plug it in again.

Software reset - carry out the following procedure:

Software reset via analog terminals / ISDN terminals

Analogue and ISDN Phones

Programming mode must be started by entering:  →      

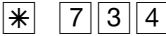







Lift handset

Reset the telephone system

Acknowledgement tone

Replace handset

The Reset is performed after ending programming mode with:  →      

Software reset via System telephones

ST 40

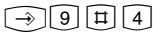

Start the function. Watch the display: If the setup code is requested after pressing the 9, you have to enter the 4-digit code.



Middle Button: The memories are cleared (approx. 2 minutes). (all data are cleared and the programming is ended automatically)

Appendix

Rings

All ringer rhythms for incoming calls begin with an initial 500 ms pulse, followed by a 2 second pause. This is a technical requirement to allow caller identification (Calling Line Identification Presentation - CLIP). Thereafter the ring can be programmed differently to distinguish between calls to different extension numbers in the system (see diagram)

Ring Rythms

External Call

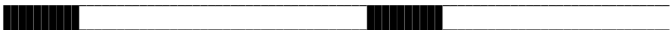
Standard Ring 

An external subscriber calls

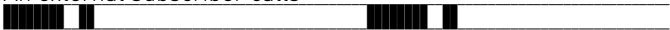
Code ring 1 

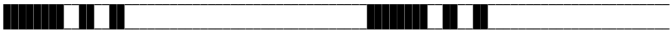
Code ring 2 

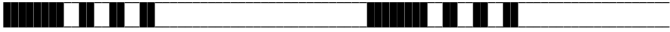
Code ring 3 

Code ring 4 

Internal Call 

An internal subscriber calls

Door ringing 

A visitor rings at the door

Code call rings to radio cells

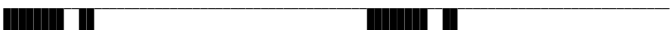
- Code ring 1 

Call via the first internal phone number

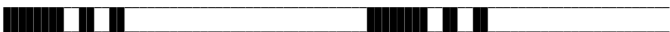
- Code ring 2 

Call via the second internal phone number

Outside line reservation / 

Appointment call (system telephone)

Wake up call (system telephone) 

1 minute rising volume

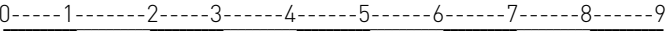
Key: 













0-----1-----2-----3-----4-----5-----6-----7-----8-----9 s
Call break Call break Continued

Note

Ringing may differ depending on the terminal used. The code calls 3 and 4 are not signalled to analog ports that are set to type „radio cell“.

Appendix

Tones

Dial tone - internal		...
	Signals that you may dial after lifting handset	
- external		...
	Continuous tone that you hear when you have seized an outside line after dialling "9" or pressing an MSN key	
Ringing tone - internal		...
	Internal user is rung	
- external		...
	External user is rung	
Busy tone		...
	The dialled internal user or external subscriber is busy	
Special dial tone		...
	Signals that you may dial after lifting the receiver, but that do not disturb, autodial or diversion is on	
Call waiting - internal / door		...
	During a call, this tone signals an internal call or a door call	
- external		...
	During a call, this tone signals an external call	After 10 seconds
Acknowledgement tone		...
	Input accepted	
Error tone - a/b -Telephone		...
	Operating error/ input rejected	
- System-telephone		...
	Operating error/ input rejected	
Key:	0-----1-----2-----3-----4-----5-----6-----7-----8-----9 s	...
		...
	tone break tone break tone	continued

Index

Index

A

About This Manual E - 2
Accepting Incoming Calls 1 - 15
Account Codes 1 - 90
Adjusting the flash time 3 - 6
Advanced Users Programmin 3 - 19
Answering station - VST A - 2
Appointment Call (Non-Recurring) 1 - 66
Auto Dialling (Hotline) 1 - 31
Automatic Call Back 1 - 52
Automatic Redial 1 - 84

B

Baby Listening / Room Monitor 1 - 48
Busy on Busy 1 - 33
Button Assignment 1 - 7

C

Call by Call 1 - 8
Call Deflection 1 - 30
Call Deflection - Forwarding a call
 during the ringing phase 1 - 30
Call Filter 1 - 91
Call Forwarding 1 - 77
Call Log 1 - 23, 1 - 45
Call Pick Up 1 - 22
Call Split (Brokers Call)switching
 between calls 1 - 44
Call Through 1 - 92
Call Transfer 1 - 17
Call waiting 1 - 16
Call Waiting/ Callback when free 1 - 19
Cancelling room monitoring 1 - 49
Carrier Access Code - on a Call
 by Call basis 1 - 43
Check contents of delivery 1 - 3
CLIP - Display Caller Number 1 - 93
Communicating a caller's
 phonenumber on the intern 1 - 72
Conference 1 - 40
Connecting a PC 3 - 3
contents of delivery 1 - 3
Cost display 1 - 5
CTI - computer telephony integration .. E - 11

D

Deactivating the special dial tone A - 9
Dialling Numbers from the Phone Book
 1 - 60
Display and delete call charges 1 - 80
Display call charges 1 - 80
Diversion from - Divert otherExtensions
 1 - 74
Diversion to -diverting calls to another phone
 1 - 75
Do Not Disturb 1 - 25

Doorphone Diversion to External Number
 1 - 69
Doorphone Night Service 1 - 68
Downloading new software 3 - 17

E

Enquiry 1 - 50
Enter Names with number buttons 1 - 54
Extended redial 1 - 84
External Acces with specific MSN 1 - 13
External Line Access 1 - 10
External S0-Connection Fixed S0-0(RJ45 Socket)
 1 - 10

F

Function Buttons - Freely programmable Function
Buttons 1 - 8, 1 - 9

G

Groups 1 - 89

H

Headset 1 - 8

I

Important notes on using analogue equipment
 E - 9
Important notes on using ISDN terminals
 E - 10
Internal S0-Connection 1 - 12

L

Least Cost Routing (LCR) 1 - 42

M

Mains Socket 1 - 3
Maintenance/ Testing 3 - 11
Making a Call 1 - 11
Malicious Call Identification (MCID) 1 - 38
Music on Hold (MoH) 2 - 4

N

Notes on programming with S- procedures
 3 - 5
Notes on using this Manual 1 - 4

O

Open Connection Cover 1 - 4
Operating the Doorphone and Door opener
 1 - 71

Index

P

Parking a Call	1 - 46
Partial Rerouting	1 - 30
Pictograms and Buttons	E - 12
Piktogramme	E - 12
Power Failure	A - 9
Programming from the system telephone	3 - 4
Programming tree	3 - 19
Programming via PC	3 - 3

R

Remote Dial Functions	1 - 37
Remote setting - Remote configuration	3 - 15
Reset the System	3 - 14
ringer rhythm	3 - 7
Rings	A - 12

S

Safety Notes	I - 5
Saftey Notes	E - 2
Setting the Ringers Tone or Pitch	1 - 4
Setting the Ringing volume	1 - 4
Setting the Speaker Volume	1 - 5
Single Button Dialling	1 - 88
Software reset	A - 11
Starting the programming mode	3 - 5
Storing Phonebook Numbers(Central Dialling Memory)	1 - 55
Switchable SO Connection SO 1(internal or external)	I - 11
Switchbox	1 - 94
Switching between Day and Night Service	1 - 26
Switching Call Forwarding	1 - 28
Switching over the door call variant ...	1 - 68
System Phone ST 40	1 - 2
System Redial	1 - 84
System requirements	3 - 3
System telephones	E - 12
System Telephones - Settings	1 - 4

T

Tables of Content	E - 3
TAPI	E - 11
Telephone Lock - Emergency/Direct Call (Baby Call)	1 - 63
The AS 281 All-In-One Telephone System	E - 6
The AS 35 All-In-One Telephone System	E - 8
The AS 35 Telephone System	E - 7
Timer Control	1 - 67
TK-Suite Set	PC - 4
TK-Suite Bill	PC - 4
TK-Suite Client	PC - 4
TK-Suite Contact	PC - 4

To place a Call on Hold	1 - 36
Tones	A - 13
Tracing a Call	1 - 39
Transfer an Outside Line	1 - 19

V

View Extension Status	1 - 53
Voice MessageAnnouncement	1 - 34

W

Wake Up Call	1 - 85
Wall Mounting	I - 4
What to do in the event of malfunctions	A - 10

Copyright

Copyright 2002 **AGFEO** GmbH & Co. KG
Gaswerkstr. 8
D-33647 Bielefeld

We reserve all rights to this documentation, this applies especially in the event of a patent award or registered utility.

The documentation may not be changed or translated manually in any other way into any language or computer language of any form by any means neither wholly nor in part without our express permission. This applies for electronic, mechanical, optical, chemical and all other media.

Trade marks and names used in this documentation are subject to the rights of the companies concerned.

Technical Modifications

The AGFEO GmbH & Co. KG reserves the right to change representations and data in this documentation in the interests of technical progress without prior notice.

This documentation has been prepared with the utmost care and is revised regularly.

Despite all care, however, technical inaccuracies and typographical errors cannot be totally ruled out. All errors which become known to us will be corrected in new editions. We are gratefully for any hints at errors in this documentation.

You can only use the numerous ISDN features of your AGFEO ISDN telecommunications system if your network operator provides them.

Declaration of Conformity

EU-Konformitätserklärung

EC-Declaration of Conformity
CE-Déclaration de Conformité

Der Hersteller: AGFEO GmbH & Co. KG

The Manufacturer:
Le Constructeur:

Adresse: Gaswerkstr. 8
D - 33647 Bielefeld

Address:
Adresse:

Erklärt, dass das Produkt: AS 281 All-In-One

Declares that the Product:
Déclare que le Produit:

Type: Telefonanlage

Model: AS 281 All-In-One

Components:

die grundlegenden Anforderungen gemäß Artikel 3 der nachstehenden EU-Richtlinien erfüllt:

meets the essential requirements according to article 3 of the following EC-Directive:
est conforme aux exigences essentielles d' article 3 de la Directive CE:

**Richtlinie 1999/5/EG des Europäischen Parlaments und des Rates vom 09. März 1999
über Funkanlagen und Telekommunikationsendeinrichtungen und die gegenseitige
Anerkennung ihrer Konformität**

Directive 1999/5/EC of the European Parliament and of the Council of 09 March 1999 relating to radio and telecommunications terminal equipment, including the mutual recognition of their conformity
Directive 1999/5/CE du Parlement européen et du Conseil du 09 mars 1999 concernant les radio et équipement terminaux de télécommunications, incluant la reconnaissance mutuelle de leur conformité

und dass die folgenden harmonisierten Normen angewandt wurden:

and that the following harmonised standards has been applied:
et que les standards harmonisés suivants ont été appliqués:

EN 55022/2003
EN 55024/2003

Bielefeld, 5. April 2006

Ort und Datum der Konformitätserklärung

Place and date of the declaration Lieu et date de la déclaration

Phone : +49(0)5 21 44 70 9-0
FAX : +49(0)5 21 44 70 9-50



Name und Unterschrift
Name and Signature Nom et Signature

EU-Konformitätserklärung

EC-Declaration of Conformity
CE-Déclaration de Conformité

Der Hersteller: AGFEO GmbH & Co. KG

The Manufacturer:
Le Constructeur:

Adresse: Gaswerkstr. 8
D - 33647 Bielefeld

Address:
Adresse:

Erklärt, dass das Produkt: AS 35

Declares that the Product:
Déclare que le Produit:

Type: Telefonanlage

Model: AS 35

Components:

die grundlegenden Anforderungen gemäß Artikel 3 der nachstehenden EU-Richtlinien erfüllt:

meets the essential requirements according to article 3 of the following EC-Directive:
est conforme aux exigences essentielles d' article 3 de la Directive CE:

**Richtlinie 1999/5/EG des Europäischen Parlaments und des Rates vom 09. März 1999
über Funkanlagen und Telekommunikationsendeinrichtungen und die gegenseitige
Anerkennung ihrer Konformität**

Directive 1999/5/EC of the European Parliament and of the Council of 09 March 1999 relating to radio and
telecommunications terminal equipment, including the mutual recognition of their conformity
Directive 1999/5/CE du Parlement européen et du Conseil du 09 mars, 1999 concernant les radio et équipement terminaux de
télécommunications, incluant la reconnaissance mutuelle de leur conformité

und dass die folgenden harmonisierten Normen angewandt wurden:

and that the following harmonised standards has been applied:
et que les standards harmonisés suivants ont été appliqués:

EN 55022/2003
EN 55024/2003

Bielefeld, 21. April 2005

Ort und Datum der Konformitätserklärung
Place and date of the declaration Lieu et date de la déclaration

Phone : +49(0)5 21 44 70 9-0
FAX : +49(0)5 21 44 70 9-50

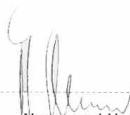

Name und Unterschrift
Name and Signature Nom et Signature

Declaration of Conformity

EU-Konformitätserklärung

EC-Declaration of Conformity
CE-Déclaration de Conformité

Der Hersteller: AGFEO GmbH & Co. KG

The Manufacturer:
Le Constructeur:

Adresse: Gaswerkstr. 8
D - 33647 Bielefeld

Address:
Adresse:

Erklärt, dass das Produkt: AS 35 All-In-One

Declares that the Product:
Déclare que le Produit:

Type: Telefonanlage

Model: AS 35 All-In-One

Components:

die grundlegenden Anforderungen gemäß Artikel 3 der nachstehenden EU-Richtlinien erfüllt:

meets the essential requirements according to article 3 of the following EC-Directive:
est conforme aux exigences essentielles d' article 3 de la Directive CE:

Richtlinie 1999/5/EG des Europäischen Parlaments und des Rates vom 09. März 1999 über Funkanlagen und Telekommunikationsendeinrichtungen und die gegenseitige Anerkennung ihrer Konformität

Directive 1999/5/EC of the European Parliament and of the Council of 09 March 1999 relating to radio and telecommunications terminal equipment, including the mutual recognition of their conformity
Directive 1999/5/CE du Parlement européen et du Conseil du 09 mars 1999 concernant les radio et équipement terminaux de télécommunications, incluant la reconnaissance mutuelle de leur conformité

und dass die folgenden harmonisierten Normen angewandt wurden:

and that the following harmonised standards has been applied:
et que les standards harmonisés suivants ont été appliqués:

EN 55022/2003
EN 55024/2003

Bielefeld, 6. Juni 2005

Ort und Datum der Konformitätserklärung
Place and date of the declaration Lieu et date de la déclaration

Phone : +49(0)5 21 44 70 9-0
FAX : +49(0)5 21 44 70 9-50

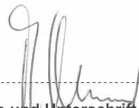

Name und Unterschrift
Name and Signature Nom et Signature



The crossed out wheeled bin on the product means that this belongs to the group of Electro- and electronic apparatus.

In this context you are directed by the European regulation to dispose of used apparatus

- at the point of buying an item of equal proportion / value
- at the local available collection point for disposal

With this you will participate in the reuse of material and valorisation of disused electric- and electronic apparatus, which otherwise could be a health hazard and be negative to the environment.



Ident no. 1100930

Subject to change without notice.

No liability can be accepted for errors contained in this document.

Printed in Germany
0067

AGFEO GmbH & Co. KG

Gaswerkstr. 8

D-33647 Bielefeld

Internet: <http://www.agfeo.com>